

# FieldFox Handheld Analyzers

4/6.5/9/14/18/26.5/32/44/50/54 GHz

N9913B	N9950B	N9933B	N9960B
N9914B	N9951B	N9934B	N9961B
N9915B	N9952B	N9935B	N9962B
N9916B	N9953B	N9936B	N9963B
N9917B		N9937B	
N9918B		N9938B	



## Table of Contents

Definitions.....	3
Cable and Antenna Analyzer and Vector Network Analyzer .....	4
TDR Cable Measurements (Option 215) .....	37
VNA Time Domain (Option 010) .....	38
Mixed-Mode S-Parameters (Option 212).....	38
Vector Voltmeter (VVM) (Option 308).....	39
Spectrum Analyzer (Option 233 on Combination Analyzers) .....	40
Tracking Generator or Independent Source .....	55
Real-Time Spectrum Analyzer (RTSA) (Option 350).....	58
I/Q Analyzer (IQA) (Option 351).....	59
Noise Figure (NF) (Option 356) .....	67
Spectrum Analyzer IF Output.....	74
Preamplifier (Option 235).....	74
Interference Analyzer and Spectrogram (Option 236).....	75
Channel Scanner (Option 312) .....	75
89600 VSA Software.....	76
Over-the-Air (OTA) LTE FDD/TDD (Option 370/371).....	77
Over-the-Air (OTA) 5G TF (Option 377) .....	78
Over-the-Air (OTA) 5G NR (Option 378).....	80
Indoor and Outdoor Mapping (Option 352).....	83
EMF Measurements (Option 358).....	84
AM/FM Analog demodulation, Tune and Listen (Option 355).....	85
Spectrum Analyzer Time Gating (Option 238).....	86
Reflection Measurements (RL, VSWR) (Option 320, applicable to SA only models).....	86
Extended Range Transmission Analysis (ERTA) (Option 209) .....	87
Built-in Power Meter (Option 310).....	93
External USB Power Sensor Support (Option 302) .....	94
Pulse Measurements (Option 330) .....	95
USB Power Sensor Measurements versus Frequency (Option 208) .....	95
Built-In GNSS (GPS+) Receiver (Option 307) .....	97
DC Bias Variable-Voltage Source (Option 309).....	97
Remote Control Capability (Option 030).....	98
EMI measurements (Option 361).....	98
General Information .....	99
FieldFox Physical Dimensions .....	103
Carry Precision With You .....	106

This data sheet provides the specified and typical performance of the FieldFox family of portable analyzers. This data sheet should be used in conjunction with the technical overviews and configuration guide, for a complete description of the analyzers.

The specifications for the 32, 44, or 50 GHz analyzers shown in this data sheet apply to the FieldFox analyzers with Serial Number prefix break  $\geq$  MY/US/SG6125, or with the RF board Part Number: N9960-63011<sup>1</sup>. If your FieldFox analyzer (32, 44, or 50 GHz) is with the older RF board (Part Number of N9960-63001<sup>1</sup>) and desire to obtain a copy of data sheet that includes specifications reflecting the previous version of hardware, you may contact Keysight technical support by creating a support case via <https://support.keysight.com/s/>.

The specifications and measurement capabilities listed in this document require certain options on the FieldFox analyzer. Refer to the FieldFox Configuration Guide to obtain option information. The configuration guide is the main resource for option/measurement capability information (<https://www.keysight.com/us/en/assets/7018-06515/configuration-guides/5992-3701.pdf>).

## Definitions

### Specification (spec)

Specifications include guard bands to account for the expected statistical performance distribution, measurement uncertainties, and changes in performance due to environmental conditions. Specifications are warranted performance. FieldFox must be within its calibration cycle. No warm-up required for the specifications listed on pages 40 through 96.

### Typical

Describes additional product performance information not covered by the product warranty. It is performance beyond specifications that 80% of the units exhibit with a 90% confidence level over the temperature range  $23 \pm 5$  °C, unless otherwise noted. Typical performance does not include measurement uncertainty. FieldFox must be within its calibration cycle.

### Nominal

A general, descriptive term or design parameter. It is not tested, and not covered by the product warranty. FieldFox must be within its calibration cycle.

---

<sup>1</sup> To find an analyzer's RF Part Number, press [System], {Service Diagnostics}, {System Information}. Here, “[ ]” denotes the hard-key, and “{ }” the soft-key.

## Cable and Antenna Analyzer and Vector Network Analyzer

The performance listed in this section applies to the cable and antenna analyzer (referred to as CAT) and vector network analyzer (VNA) capabilities available in the following models:

FieldFox RF & microwave (combination) analyzers: N9913B, N9914B, N9915B, N9916B, N9917B, N9918B, N9950B, N9951B, N9952B, N9953B

NOTE: Combination analyzers = Cable and antenna tester (CAT) + Vector network analyzer (VNA) + Spectrum analyzer (SA)

See [FieldFox Configuration Guide](#) for option information. Many capabilities listed in this Data Sheet require options.

### Frequency specifications

	Models	Frequency range
N991xB	N9913B	30 kHz to 4 GHz
	N9914B	30 kHz to 6.5 GHz
	N9915B	30 kHz to 9 GHz
	N9916B	30 kHz to 14 GHz
	N9917B	30 kHz to 18 GHz
	N9918B	30 kHz to 26.5 GHz
N995xB	N9950B	300 kHz to 32 GHz
	N9951B	300 kHz to 44 GHz
	N9952B	300 kHz to 50 GHz
	N9953B	300 kHz to 54 GHz
<b>Frequency reference, -10 to 55 °C</b>		
Accuracy	± 0.9 ppm (spec) + aging	
	± 0.5 ppm (typical) + aging	
Accuracy, when locked to GPS	± 0.010 ppm (spec)	
Accuracy, when GPS antenna is disconnected	± 0.4 ppm (nominal) <sup>1</sup>	
Aging Rate	± 1 ppm/yr for 20 years (spec), will not exceed ± 3.5 ppm	
<b>Frequency resolution</b>	<b>Spec (Hz)</b>	
30 kHz to 1.91211 GHz	0.67	N991xB, or N995xB (starting 300 kHz)
≥ 1.91211 to 3.82461 GHz	1.34	N991xB, or N995xB
≥ 3.82461 to 7.64961 GHz	2.68	N991xB, or N995xB
≥ 7.64961 to 15.29961 GHz	5.36	N991xB, or N995xB
≥ 15.29961 to 26.5 GHz	10.73	N991xB, or N995xB
≥ 26.5 to 45.8 GHz	16.09	N995xB
≥ 45.8 to 54 GHz	32.19	N995xB

<sup>1</sup> The maximum drift expected in the frequency reference applicable when the ambient temperature changes ±5°C from the temperature when the GPS signal was last connected.

<b>Data points or resolution</b>	101, 201, 401, 601, 801, 1001, 1601, 4001, 10,001 Arbitrary number of points settable through front panel and SCPI
<b>IF bandwidth<sup>1</sup></b>	3 Hz, 10 Hz, 30 Hz, 100 Hz, 300 Hz, 1 kHz, 3 kHz, 10 kHz, 30 kHz, 100 kHz
<b>System impedance</b>	50 $\Omega$ (nominal), 75 $\Omega$ with appropriate adapter and calibration kit

---

<sup>1</sup> VNA mode only. Recommend using averaging in CAT mode.

## Cable and Antenna Analyzer and Vector Network Analyzer (continued)

### Test port output specifications

**High power** in the N991xB and N995xB refers to the analyzer's target output power level when the *Power Setting* is *High*. Examples:

- N991xB: For a 5 to 10 GHz frequency sweep, the analyzer achieves a 7 dBm power level across the band.
- N995xB: For an 18 to 26.5 GHz frequency sweep, the analyzer achieves a 5 dBm power level across the band.

**Low power** level for N991xB and N995xB analyzers flattens at -50 dBm across the entire frequency band and is the analyzer's output when the *Power Setting* is *Low*.

**Max leveled power** in the N991xB and N995xB refers to the maximum leveled (flattened) power achieved across the designated frequency range. Examples:

- N991xB: For a 1 to 10 GHz frequency sweep with the analyzer configured to measure all four S-parameters, needing both ports 1 and 2, the maximum power the analyzer can be set to is 5 dBm.
- N995xB: For an 18 to 26.5 GHz frequency sweep with the analyzer configured to measure all four S-parameters, needing both ports 1 and 2, the maximum power the analyzer can be set to is 4 dBm.

Test port output power (dBm), high power	Typical	Typical
<b>N991xB</b>	<b>Port 1</b>	<b>Port 2</b>
30 kHz to 500 kHz	-4	-2
> 500 kHz to 10 MHz	0	0
> 10 MHz to 1 GHz	9	8
> 1 to 5 GHz	8	7
> 5 to 10 GHz	7	7
> 10 to 18 GHz	6	5
> 18 to 26.5 GHz	3	2
<b>N995xB</b>	<b>Port 1</b>	<b>Port 2</b>
300 kHz to 1 MHz	-5	-4
> 1 MHz to 10 MHz	-1	-1
> 10 MHz to 6 GHz	5	5
> 6 to 18 GHz	6	5
> 18 to 26.5 GHz	4	4
> 26.5 to 32 GHz	2	1
> 32 to 40 GHz	2	-1
> 40 to 44 GHz	-3	-2
> 44 to 50 GHz	-4	-5
> 50 to 54 GHz	-8	-8

Test port output power (dBm), low power		Typical Port 1 or Port 2	Nominal Port 1 or Port 2
<b>N991xB</b>	30 kHz to 26.5 GHz	-50 dBm (flattened) $\pm 0.5$ dB	—
<b>N995xB</b>	300 kHz to 54 GHz	-50 dBm (flattened) $\pm 0.5$ dB	—
Max leveled output power (dBm)		Nominal Port 1	Nominal Port 2
<b>N991xB</b>			
> 10 MHz to 1 GHz		6	6
> 1 to 10 GHz		6	5
> 10 to 18 GHz		4	3
> 18 to 26.5 GHz		2	0
<b>N995xB</b>			
> 300 kHz to 1 MHz		-4	-4
> 1 MHz to 10 MHz		7	6
> 10 MHz to 6 GHz		8	7
> 6 to 18 GHz		5	4
> 18 to 26.5 GHz		3	3
> 26.5 to 32 GHz		2	1
> 32 to 44 GHz		1	-2
> 44 to 50 GHz		-5	-6
> 50 to 54 GHz		-9	-9

Output power range	
CAT	High, low, and manual. Default (preset) power is manual, -15 dBm. Manual power is flattened.
VNA	High, low, and manual. Default (preset) power is manual, -15 dBm. Manual power is flattened.
Power step size	
	Power settable in 1 dB steps across power range. Flat power, in 1 dB steps, is available across the whole frequency span, nominal.

## Cable and Antenna Analyzer and Vector Network Analyzer (continued)

### Test port output specifications (continued)

Power level accuracy <sup>4</sup>	Typical
<b>N991xB<sup>1</sup></b>	<b>Port 1 or Port 2 at -15 dBm</b>
30 kHz to 10 MHz	± 0.7 dB
> 10 MHz to 26.5 GHz	± 0.5 dB
<b>N995xB<sup>1</sup></b>	<b>Port 1 or Port 2 at -15 dBm</b>
300 kHz to 54 GHz	± 0.5 dB
Power level linearity	Nominal
<b>N991xB</b>	<b>Port 1 or Port 2, -50 dBm ≤ P &lt; max leveled power</b>
> 10 MHz to 26.5 GHz	± 0.5 dB
<b>N995xB</b>	<b>Port 1 or Port 2, -60 dBm ≤ P &lt; max leveled power</b>
> 300 kHz to 54 GHz	± 0.5 dB

### System performance specifications

System dynamic range <sup>2,3</sup> (dB), high power, 300 Hz IFBW, 100-point average, Port 1 or Port 2 (-10 to 55°C)				
N991xB	S12 Spec	S12 Typical	S21 Spec	S21 Typical
30 kHz to 1 MHz	--	114 (nominal)	--	113 (nominal)
> 1 to 6.34 MHz	105	114	104	111
> 6.34 MHz to 16 GHz	108	114	106	116
> 16 to 18 GHz	109	117	104	114
> 18 to 24 GHz	105	115	102	113
> 24 to 26.5 GHz	102	113	97	109
N995xB	S12 Spec	S12 Typical	S21 Spec	S21 Typical
300 kHz to 1 MHz	--	105 (nominal)	--	104 (nominal)
> 1 to 10 MHz	102	113	100	111
> 10 MHz to 6 GHz	109	121	107	120
> 6 to 16 GHz	106	117	105	118
> 16 to 18 GHz	107	119	104	117
> 18 to 24 GHz	106	117	102	116
> 24 to 26.5 GHz	102	115	100	115
> 26.5 to 32 GHz	97	111	98	111
> 32 to 39 GHz	92	107	96	110
> 39 to 46 GHz	89	101	86	103
> 46 to 50 GHz	85	99	85	98
> 50 to 54 GHz	80	94	79	95

<sup>1</sup> N995xB power levels are calibrated based on PNA-X's tuned receiver for the entire frequency range.

<sup>2</sup> System dynamic range is measured in the factory with loads on the test ports after a thru normalization.

<sup>3</sup> For CAT mode, "Insertion loss (2-port)", decrease listed dynamic range specifications by 20 dB, as CAT mode IFBW is fixed at 10 kHz. Can obtain full dynamic range by using S21 measurement in VNA mode with 100 Hz IFBW.



Measurement stability over temperature		Nominal	
	Frequency	Magnitude (dB/°C)	Phase (deg/°C)
<b>N991xB</b>	≤ 6 GHz	± 0.010	± 0.15
	> 6 to 15 GHz	± 0.025	± 0.5
	> 15 to 26.5 GHz	± 0.035	± 0.5
<b>N995xB</b>	300 kHz to 2 MHz	± 0.018	± 0.88
	2 MHz to 6 GHz	± 0.008	± 0.12
	6 to 15 GHz	± 0.016	± 0.32
	15 to 26.5 GHz	± 0.025	± 0.55
	26.5 to 40 GHz	± 0.033	± 0.85
	40 to 50 GHz	± 0.06	± 1.4
	50 to 54 GHz	± 0.05	± 1.5

Measurement speed (Sweep time)		
CAT	N991xB	N995xB
Return loss, 30 kHz to 26.5 GHz, 1-port cal, 1001 points	409 μs /pt	-
Return loss, 300 kHz to 54 GHz, 1-port cal 1001 points	-	457 μs /pt
Distance-to-fault, 100-meter cable, 1-port cal, 1001 points	470 μs /pt	506 μs /pt
VNA	N991xB	N995xB
S11 and S21, 30 kHz to 26.5 GHz, enhanced response cal, 100 kHz IF bandwidth, 1001 points	171 μs /pt	-
S11 and S21, 300 kHz to 54 GHz, enhanced response cal, 100 kHz IF bandwidth, 1001 points	-	196 μs /pt

## Cable and Antenna Analyzer and Vector Network Analyzer (continued)

### Test port input specifications

Trace noise <sup>1</sup> , high power, 300 Hz IFBW, Port 1 or Port 2		Spec (-10 to 55 °C)	
	Frequency	Magnitude (dB rms)	Phase (deg rms)
N991xB	30 kHz to 100 kHz	0.0008 (nominal)	0.007 (nominal)
	≥ 100 kHz to 5 GHz	0.0010	0.005
	> 5 to 15 GHz	0.0014	0.014
	> 15 to 26.5 GHz	0.0020	0.027
N995xB	≥ 300 kHz to 34 MHz <sup>2</sup>	0.0010	0.0070
	> 34 MHz to 5 GHz	0.0010	0.0070
	> 5 to 15 GHz	0.0014	0.0140
	> 15 to 26.5 GHz	0.0020	0.0270
	> 26.5 to 32 GHz	0.0030	0.0500
	> 32 to 44 GHz	0.0040	0.0600
	> 44 to 50 GHz	0.0040	0.1200
> 50 to 54 GHz	0.0120	0.5000	

Receiver compression		Typical
	Frequency	Port 1 or Port 2
N991xB	250 kHz to 2 GHz	+8 dBm, 0.20 dB compression
	> 2 to 5 GHz	+8 dBm, 0.15 dB compression
	> 5 to 26.5 GHz	+8 dBm, 0.10 dB compression
N995xB	300 kHz to 7 MHz	+5 dBm, 0.20 dB compression
	> 7 MHz to 26.5 GHz	+5 dBm, 0.10 dB compression
	> 26.5 to 54 GHz	+5 dBm, 0.15 dB compression

Maximum input level		Port 1 or Port 2	
	Average CW power	DC	
N991xB	+27 dBm, 0.5 watts	± 50 VDC	
N995xB	+25 dBm, 0.3 watts	± 40 VDC	
Immunity to interfering signals (Nominal)		N991xB	N995xB
On carrier frequency		+10 dBm	+9 dBm
Offset from carrier frequency	> 1 MHz	+13 dBm	+12 dBm
	> 10 MHz	+18 dBm	+8 dBm

<sup>1</sup> For CAT mode, increase trace noise by a factor of 5.7, as CAT mode IFBW is fixed at 10 kHz. Can use averaging in CAT mode to reduce trace noise or use VNA mode with 300 Hz IFBW.

<sup>2</sup> Excludes multiples of 65 kHz, and 7.792198 MHz, 8.190585 MHz, and 8.954400 MHz.

## CAT and VNA measurements

CAT mode	
CAT measurements	Distance-to-fault (dB) Return loss (dB) Return loss & DTF (dB) VSWR Distance-to-fault (VSWR) Cable loss (1-port) Insertion loss (2-port) (requires option 211) Distance-to-fault (Lin) TDR (Lin rho) (requires option 215) TDR (ohm) (requires option 215) TDR & DTF (requires option 215)
Distance-to-fault (DTF) settings	
Frequency/distance	Start distance, stop distance
Sweep time	Units: meters or feet (Can also be set as Preferences)
Frequency mode	Bandpass, lowpass
CAT mode averaging	Set sweep time in seconds

## Cable and Antenna Analyzer and Vector Network Analyzer (continued)

### CAT and VNA measurements (continued)

<b>CAT mode (continued)</b>	
Distance-to-fault	Available in CAT mode. Standard on N991xB analyzers. Range = velocity factor x speed of light x (number of points -1) / frequency span x 2; Number of points auto coupled according to start and stop distance entered. Resolution = range / (number of points -1) Transform modes: Bandpass, low-pass Window types: Maximum, medium, and minimum Alias free range indicator: On/Off Dispersion compensation for waveguide: Yes
Return loss, log magnitude	-500 to 500 dB
Log magnitude resolution	0.01 dB
VSWR	1.01 to 1000
VSWR resolution	0.01
<b>VNA mode</b>	
VNA Transmission/Reflection (T/R)	S11, S21 magnitude and phase (requires option 210)
VNA S-parameters	S11, S21, S22, S12 magnitude and phase (requires options 210 and 211)
Number of traces	Four traces available: Tr1, Tr2, Tr3, Tr4
Display formats	Single-trace Dual-trace split (each trace on separate graticule) Dual-trace overlay (both traces on one graticule) Three-trace split (each trace on separate graticule) Three-trace overlay (all three traces on one graticule) Quad-trace split (each trace on separate graticule) Quad-trace overlay (all four traces on one graticule)
VNA trace formats	Log magnitude, linear magnitude, VSWR, phase, Smith chart, polar, group delay, unwrapped phase, real impedance, imaginary impedance, Z magnitude
Frequency settings	Start, stop, center, span
Frequency sweep type	Linear
Sweep type trigger	Continuous, single
Sweep trigger source	Internal, external, point (point trigger applies to 1-port cal only)
Sweep trigger slope	Positive, negative
Sweep trigger delay	0 to 10 seconds
Averaging	Sweep: 2 to 1000; Point: 2 to 500
Smoothing	Computes the moving average of adjacent data points. Smoothing aperture defines the trace width (number of points) to be averaged. Minimum aperture: 0.05% of frequency span Maximum aperture: 25% of frequency span

## Cable and Antenna Analyzer and Vector Network Analyzer (continued)

### CAT and VNA measurements (continued)

VNA mode (continued)	
Scale	Autoscale, scale, reference level, reference position Autoscale: Automatically selects scale resolution and reference value to center the trace. Autoscale all: Scales all visible traces.
S11, log magnitude	-500 to 500 dB
Log magnitude resolution	0.01 dB
VSWR	1.01 to 1000
VSWR resolution	0.01
Phase	-180 to +180 degrees (unwrapped phase can show larger values)
Phase resolution	0.01 degrees
Phase offset	-360 to +360 degrees
Magnitude offset	-100 to +100 dB
Trace math	Vector division or subtraction of current linear measurement values and memory data
Port extension	For both port 1 and port 2, delay settings. Port extensions apply to all measurements.
Marker formats	Default marker format is the trace format. Other formats: R + jX Z magnitude Phase Real Imaginary Mag & Phase dB Angle
General CAT / VNA modes	
Marker functions	Peak, Next Peak, Peak Left, Peak Right, Mkr→Center, Mkr→Delay, Min Search, Peak Excursion, Peak Threshold, Target, Bandwidth (BW, Q, Loss), Tracking CAT mode only: Tracking 3 peaks (CAT mode), Mkr→Start distance, Mkr→Stop distance
Marker table	On/Off
Marker types	Normal, delta, data trace and memory trace markers
Marker coupling	On/Off (coupling between traces)
Frequency blanking	Security level: none, high. If high, all frequency information is blanked out. An instrument preset is required to re-enable the frequency information.
Display data	Display data, memory, data and memory, or data math
Trace math	One memory trace per data trace.

## Cable and Antenna Analyzer and Vector Network Analyzer (continued)

### CAT and VNA mode Calibrations

FieldFox analyzers offer three tiers of calibrations, thus providing users with different levels of calibration effort and accuracy.

#### CalReady

CalReady is the most basic calibration and is sufficient for a quick pass/fail or go/no go verification. Every FieldFox is calibrated at the factory, at test ports 1 and 2, at room temperature. CalReady can be applied either as an “enhanced response CalReady” or a “2-port CalReady.” The default setting is 2-port CalReady, so correction is applied to both ports. A user preference allows user to change the CalReady methodology to enhanced response CalReady.

A 30-minute warm-up period is recommended for a quick test. A 60-minute warm-up is necessary for more stringent test requirements.

If CalReady is the basis for most measurements, the annual cal cycle must be followed, as the CalReady calibration will be updated during the annual cal cycle.

## Cable and Antenna Analyzer and Vector Network Analyzer (continued)

### Standard calibrations

Standard calibrations are the most accurate calibrations offered in FieldFox. FieldFox's calibration engine is based on Keysight's flagship PNA calibration engine, and as such, offers many of the standard calibrations. FieldFox supports both coaxial and waveguide calibrations. The table below lists the commonly used calibrations.

Keysight recommends a 30-minute warm-up period for standard calibrations. For ultimate in stability and accuracy, a 90-minute warm-up period is necessary.

<b>Frequency response</b> <b>Open response</b> <b>Short response</b> <b>Thru response</b> <b>With and without isolation</b>	Simultaneous magnitude and phase correction of frequency response errors for either reflection or transmission measurements. Isolation corrects for crosstalk errors.
<b>1-port OSL (Port 1)</b> <b>1-port OSL (Port 2)</b>	Open, short, and load Traditional 1-port calibration for reflection measurements. Corrects for directivity, source match, and frequency response errors.
<b>SSL (for waveguide)</b>	For waveguide calibrations, depending on the calibration kit definition, this is presented as a short, offset short and load calibration.
<b>Enhanced response (also known as one-path, two-port)</b> <b>Forward enhanced response</b> <b>Reverse enhanced response</b>	Corrects for frequency response and source match. Partial correction for load match for low-loss reciprocal devices.
<b>QSOLT (2-port)</b>	QSOLT or Quick short-open-load-thru is FieldFox's default recommended calibration for insertable devices. Full 12-term error correction. Requires fewer connections, compared to traditional SOLT (4 compared to 7). Corrects for directivity, source match, reflection frequency response, load match, and transmission frequency response.
<b>Full 2-port (unknown thru calibration)</b>	FieldFox's default recommended calibration for non-insertable devices. Full 12-term error correction. Beneficial for characterizing non-insertable devices such as Type-N to 3.5 mm, or female-female devices. Corrects for directivity, source match, reflection frequency response, load match, and transmission frequency response.
<b>TRL</b>	TRL or thru-reflect-line compensates for directivity, reflection, and transmission frequency response in both the forward and reverse directions.

\*\* Note: FieldFox does not offer the traditional SOLT calibration. Instead, it offers the more accurate Full 2-port (unknown thru), and QSOLT.

### ECal

FieldFox supports all Keysight USB ECal modules, both standard and value-line ECals.

### FieldFox's Guided Calibration Wizard

FieldFox's calibration wizard recommends a calibration type and calibration kit based on selected parameters and connector types. Alternatively, users can select their own calibration type and calibration kit. FieldFox's calibration wizard ensures a valid calibration selection.

## Cable and Antenna Analyzer and Vector Network Analyzer (continued)

### Interpolation Error Correction

With any type of accuracy enhancement applied, interpolated mode recalculates the error coefficients when the test frequencies are changed. The number of points can be increased or decreased, and the start/stop frequencies can be changed, but the resulting frequency span must be a subset of the original calibration frequency span.

### Connectors

The FieldFox firmware supports the following connector types by default. Add other connector types with a calibration kit that contains the connector type.

Coaxial	Waveguide	
Type-N 50 ohm	WR-10	WR-90
Type-N 75 ohm	WR-15	WR-112
7/16	WR-22	WR-137
TNC	WR-28	WR-187
Type-F	WR-42	WR-284
7 mm	WR-62	WR-650
3.5 mm	WR-75	
2.92 mm		
2.4 mm		
1.85 mm		

### FieldFox S-parameter measurement uncertainties

The configurations listed below include measurement uncertainties based on ISO GUM methodology calculations.

FieldFox model	Calibration kit	Calibration type	DUT connector	Uncertainty
N991xB, N995xB	85518A or 85519A	Full 2-port calibration	Type-N	Spec
N991xB, N995xB	85054D	Full 2-port calibration	Type-N	Spec
N991xB, N995xB	85520A or 85521A	Full 2-port calibration	3.5 mm	Spec
N991xB, N995xB	85052D	Full 2-port calibration	3.5 mm	Spec
N991xB, N995xB	N7554A	Full 2-port calibration	Type-N	Spec
N991xB, N995xB	N7555A	Full 2-port calibration	3.5 mm	Spec
N991xB, N995xB	N4690D	Full 2-port calibration	Type-N	Spec
N991xB, N995xB	N4691D	Full 2-port calibration	3.5 mm	Spec
N995xB	85561A or 85562A	Full 2-port calibration	2.92 mm	Spec
N995xB	BN 534913 or BN934914	Full 2-port calibration	2.92 mm	Spec
N995xB	N4692D	Full 2-port calibration	2.92 mm	Spec
N995xB	85563A or 85564A	Full 2-port calibration	2.4 mm	Spec
N995xB	85056D	Full 2-port calibration	2.4 mm	Spec
N995xB	N4693D ECal	Full 2-port calibration	2.4 mm	Spec
N995xB	85058E	Full 2-port calibration	1.85 mm	Spec
N995xB	N4694A/D ECal	Full 2-port calibration	1.85 mm	Spec



## Corrected Measurement Uncertainty (continued)

N9913/4/5/6/7/8B, 85518A or 85519A, Full 2-port Cal, DUT: Type-N, Spec

Corrected performance table calculated using uncertainties with a coverage factor of 2.

Corrected performance (dB)	0.2 to 500 MHz	0.5 to 6 GHz	6 to 9 GHz	9 to 18 GHz
Directivity	40	39	32	29
Source match	38	31	29	26
Load match <sup>1</sup>	38	33	28	26
Reflection tracking	± 0.00011	± 0.033	± 0.014	± 0.043
Transmission tracking <sup>1</sup>	± 0.062	± 0.17	± 0.29	± 0.32

Uncertainty plots: power level of -15 dBm, 10 Hz IF bandwidth, no averaging, battery saver off, and 60-minute warm-up time. Includes uncertainties due to drift, noise, compression, and dynamic accuracy. Coverage factor of 1 applied to uncertainties, for ease of comparison with other industry handheld analyzers.

### Transmission uncertainty (S21, S12)

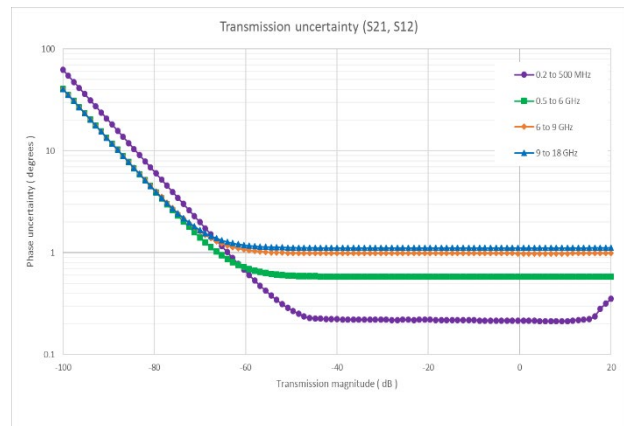
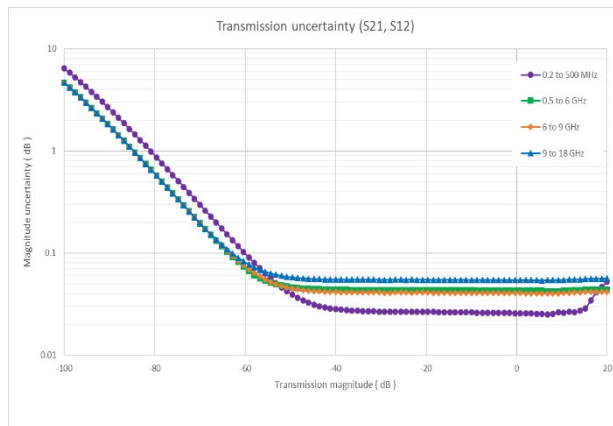

### Reflection uncertainty (S11, S22)

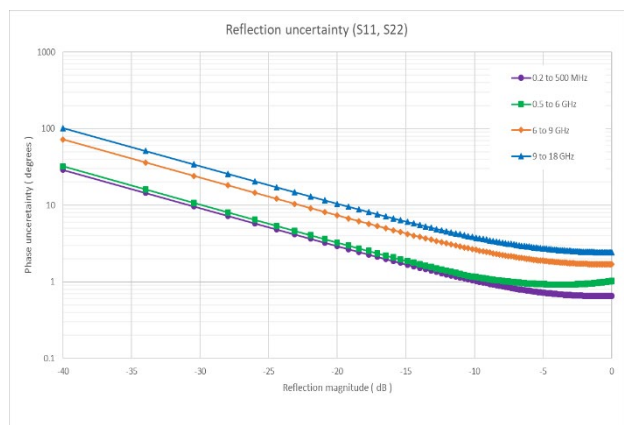
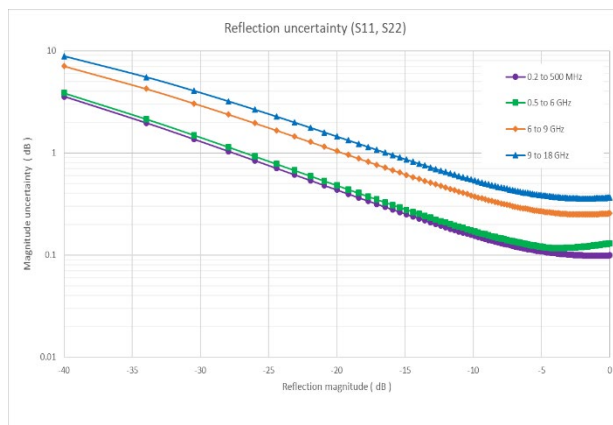

<sup>1</sup> Load match and transmission tracking are typical values.

## Corrected Measurement Uncertainty (continued)

N9913/4/5/6/7/8B, 85054D, Full 2-port Cal, DUT: Type-N, Spec

Corrected performance table calculated using uncertainties with a coverage factor of 2.

Corrected performance (dB)	0.2 to 500 MHz	0.5 to 2 GHz	2 to 8 GHz	8 to 18 GHz
Directivity	37	37	33	31
Source match	37	37	33	30
Load match <sup>1</sup>	37	37	33	30
Reflection tracking	± 0.00068	± 0.0019	± 0.0053	± 0.026
Transmission tracking <sup>1</sup>	± 0.0057	± 0.017	± 0.053	± 0.12

Uncertainty plots: power level of -15 dBm, 10 Hz IF bandwidth, no averaging, battery saver off, and 60-minute warm-up time. Includes uncertainties due to drift, noise, compression, and dynamic accuracy. Coverage factor of 1 applied to uncertainties, for ease of comparison with other industry handheld analyzers.

### Transmission uncertainty (S21, S12)

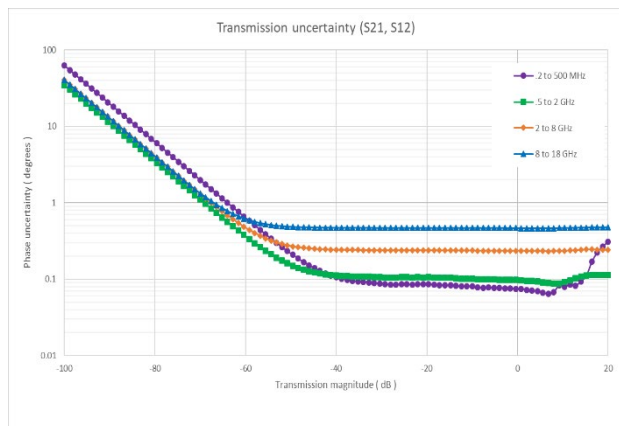
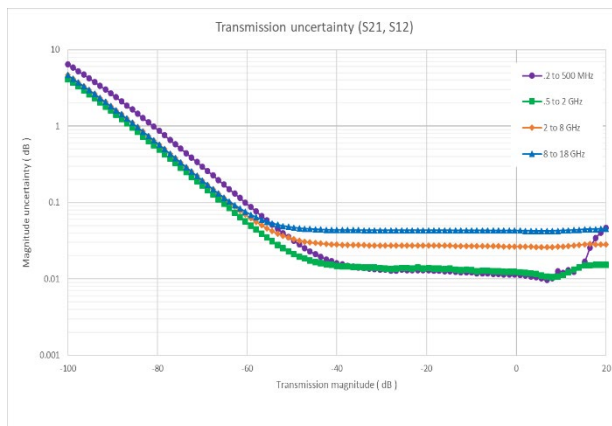

### Reflection uncertainty (S11, S22)

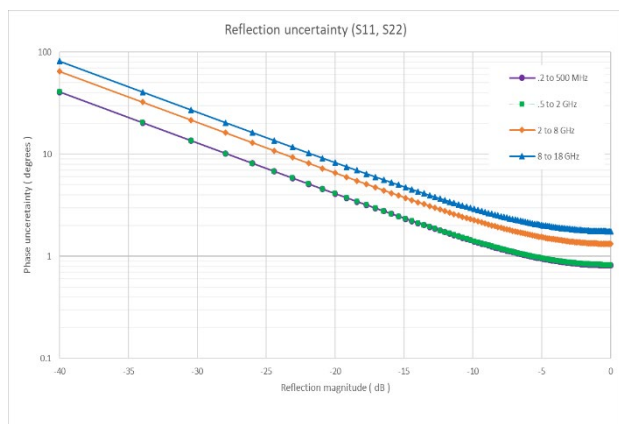
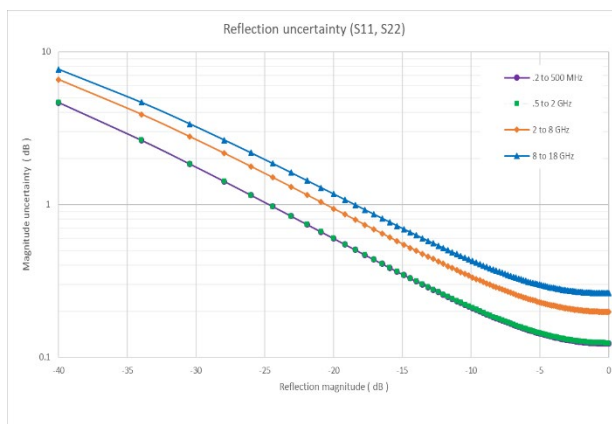

<sup>1</sup> Load match and transmission tracking are typical values.

## Corrected Measurement Uncertainty (continued)

N9913/4/5/6/7/8B, 85520A or 85521A, Full 2-port Cal, DUT: 3.5 mm, Spec

Corrected performance table calculated using uncertainties with a coverage factor of 2.

Corrected performance (dB)	0.2 to 500 MHz	0.5 to 5 GHz	5 to 15 GHz	15 to 26.5 GHz
Directivity	41	39	33	29
Source match	34	33	29	25
Load match <sup>1</sup>	35	32	28	24
Reflection tracking	± 0.0078	± 0.022	± 0.024	± 0.060
Transmission tracking <sup>1</sup>	± 0.13	± 0.18	± 0.29	± 0.45

Uncertainty plots: power level of -15 dBm, 10 Hz IF bandwidth, no averaging, battery saver off, and 60-minute warm-up time. Includes uncertainties due to drift, noise, compression, and dynamic accuracy. Coverage factor of 1 applied to uncertainties, for ease of comparison with other industry handheld analyzers.

### Transmission uncertainty (S21, S12)

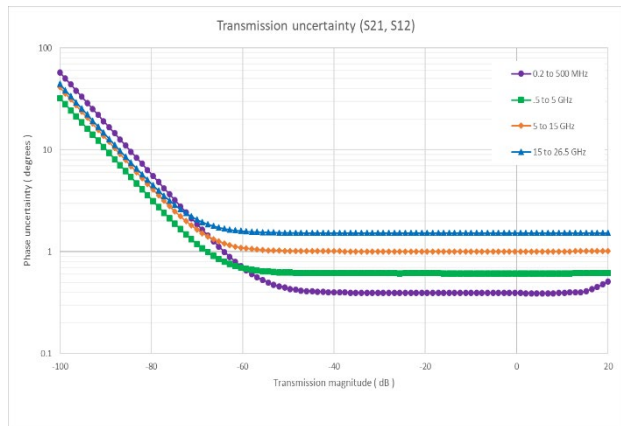
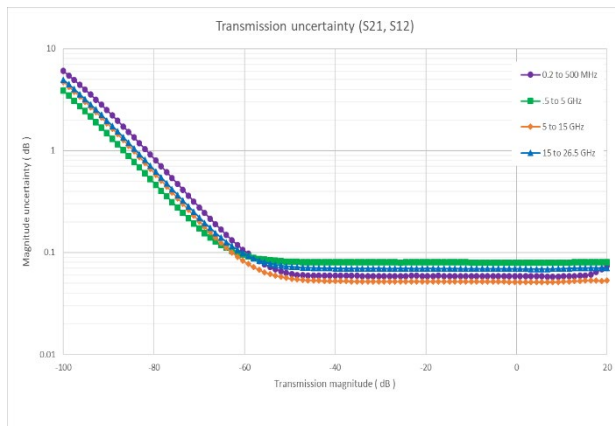

### Reflection uncertainty (S11, S22)

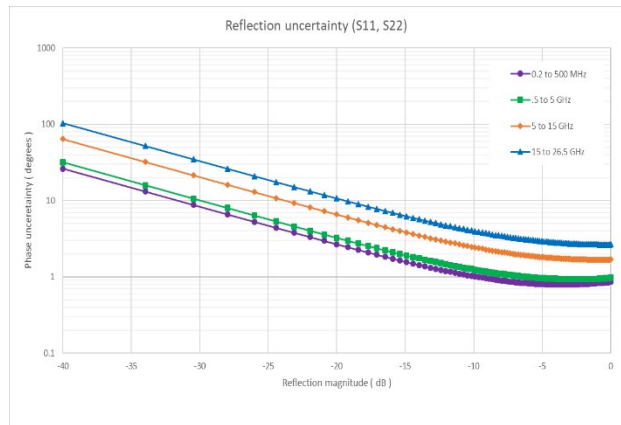
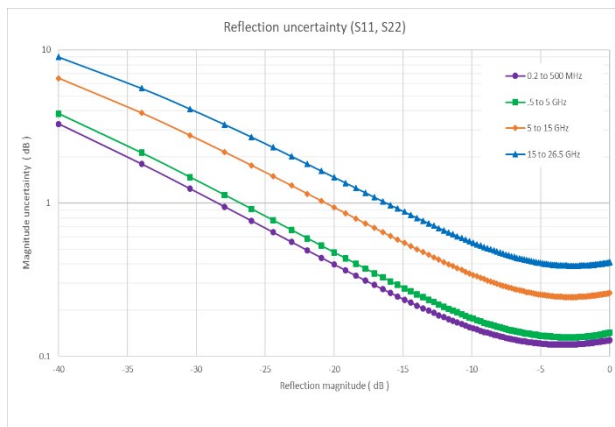

<sup>1</sup> Load match and transmission tracking are typical values.

## Corrected Measurement Uncertainty (continued)

N9913/4/5/6/7/8B, 85052D, Full 2-port Cal, DUT: 3.5 mm, Spec

Corrected performance table calculated using uncertainties with a coverage factor of 2.

Corrected performance (dB)	0.2 MHz to 3 GHz	3 to 8 GHz	8 to 20 GHz	20 to 26.5 GHz
Directivity	41	35	33	31
Source match	40	34	31	30
Load match <sup>1</sup>	40	33	30	29
Reflection tracking	± 0.0019	± 0.0085	± 0.021	± 0.019
Transmission tracking <sup>1</sup>	± 0.053	± 0.12	± 0.20	± 0.20

Uncertainty plots: power level of -15 dBm, 10 Hz IF bandwidth, no averaging, battery saver off, and 60-minute warm-up time. Includes uncertainties due to drift, noise, compression, and dynamic accuracy. Coverage factor of 1 applied to uncertainties, for ease of comparison with other industry handheld analyzers.

### Transmission uncertainty (S21, S12)

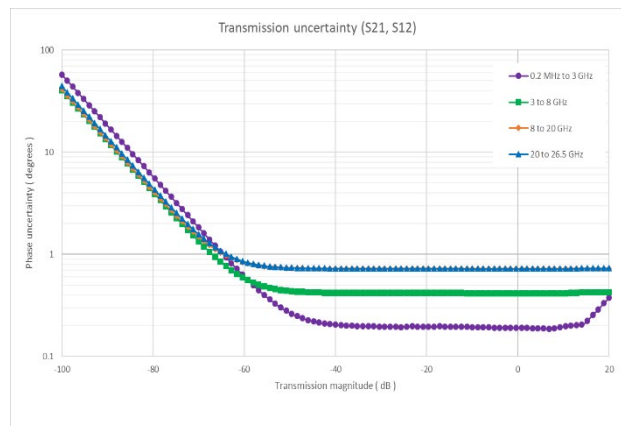
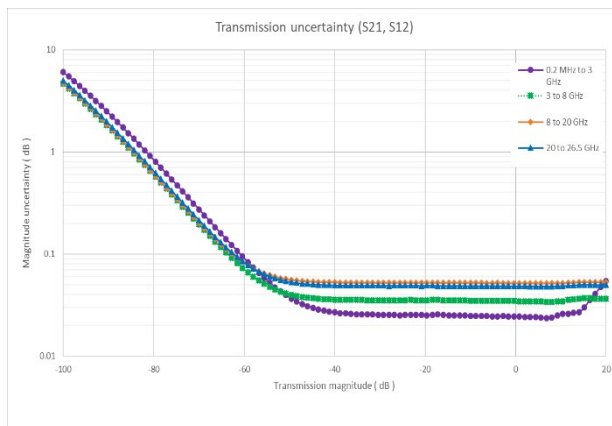

### Reflection uncertainty (S11, S22)

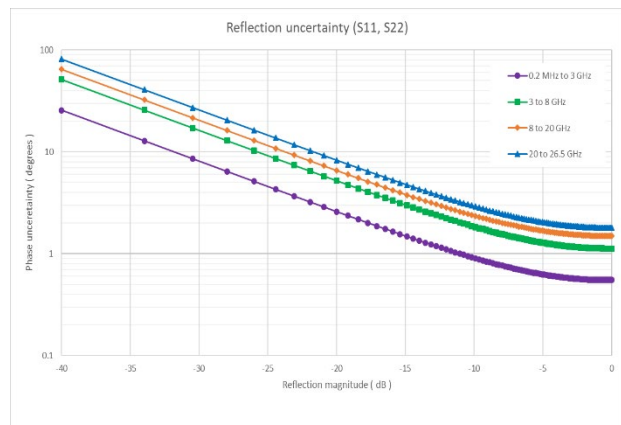
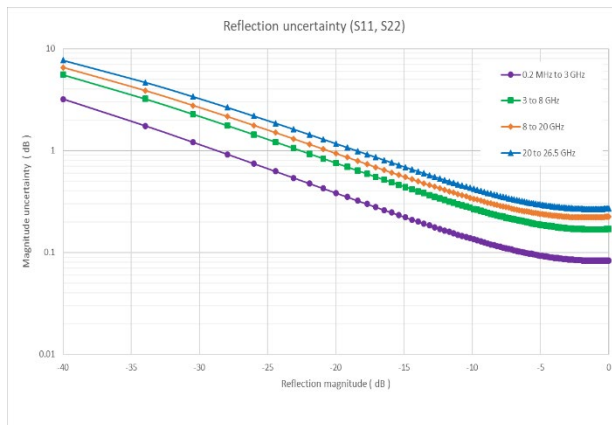

<sup>1</sup> Load match and transmission tracking are typical values.

## Corrected Measurement Uncertainty (continued)

N9913/4/5/6/7/8B, N7554A ECal, Full 2-port Cal, DUT: Type-N, Spec

Corrected performance table calculated using uncertainties with a coverage factor of 2.

Corrected performance (dB) <sup>1</sup>	0.2 MHz to .5 GHz	0.5 to 4 GHz	4 to 9 GHz	9 to 18 GHz
Directivity	42	36	36	36
Source match	37	30	30	28
Load match <sup>2</sup>	37	30	30	28
Reflection tracking	± 0.13	± 0.13	± 0.18	± 0.25
Transmission tracking <sup>2</sup>	± 0.13	± 0.13	± 0.18	± 0.25

Uncertainty plots: power level of -15 dBm, 10 Hz IF bandwidth, no averaging, battery saver off, and 60-minute warm-up time. Includes uncertainties due to drift, noise, compression, and dynamic accuracy. Coverage factor of 1 applied to uncertainties, for ease of comparison with other industry handheld analyzers.

### Transmission uncertainty (S21, S12)

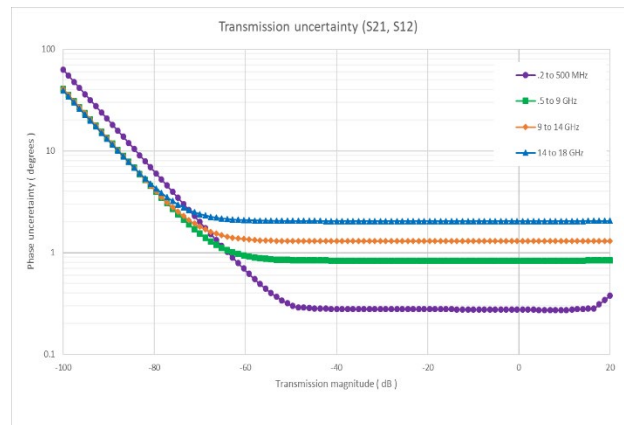
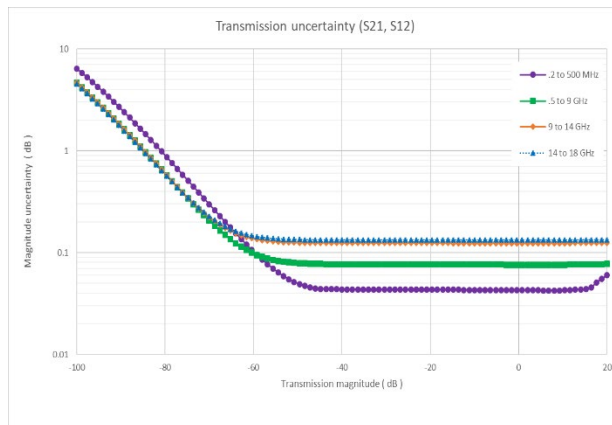

### Reflection uncertainty (S11, S22)

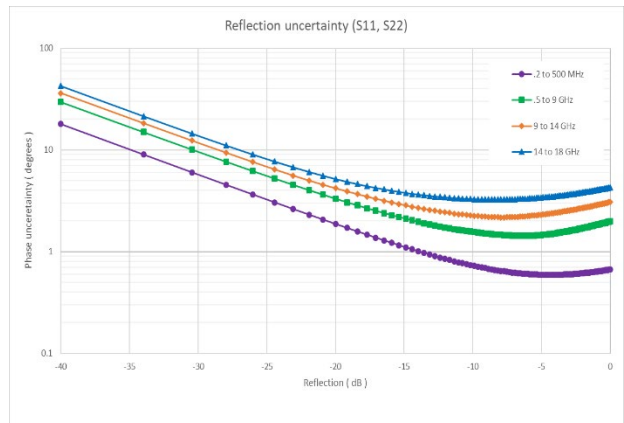
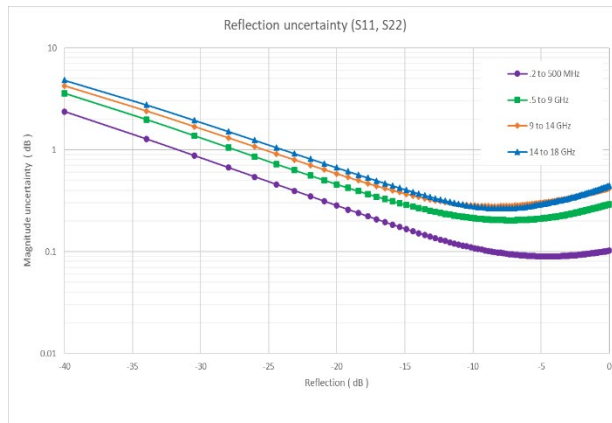

<sup>1</sup> When applied power exceeds -10 dBm, calibration results will be degraded from the performance indicated in this table.

<sup>2</sup> Load match and transmission tracking are typical values.

## Corrected Measurement Uncertainty (continued)

N9913/4/5/6/7/8B, N7555A ECal, Full 2-port Cal, DUT: 3.5 mm, Spec

Corrected performance table calculated using uncertainties with a coverage factor of 2.

Corrected performance (dB) <sup>1</sup>	0.2 MHz to .5 GHz	0.5 to 4 GHz	4 to 9 GHz	9 to 18 GHz	18 to 26.5 GHz
Directivity	42	36	36	36	36
Source match	37	30	30	28	27
Load match <sup>2</sup>	37	30	30	28	27
Reflection tracking	± 0.13	± 0.13	± 0.18	± 0.25	± 0.30
Transmission tracking <sup>2</sup>	± 0.13	± 0.13	± 0.18	± 0.25	± 0.30

Uncertainty plots: power level of -15 dBm, 10 Hz IF bandwidth, no averaging, battery saver off, and 60-minute warm-up time. Includes uncertainties due to drift, noise, compression, and dynamic accuracy. Coverage factor of 1 applied to uncertainties, for ease of comparison with other industry handheld analyzers.

### Transmission uncertainty (S21, S12)

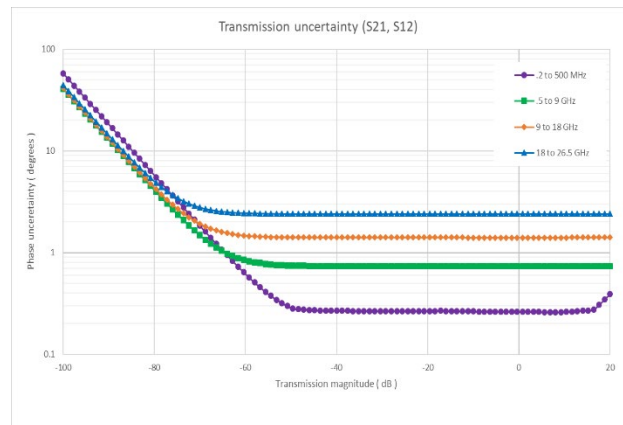
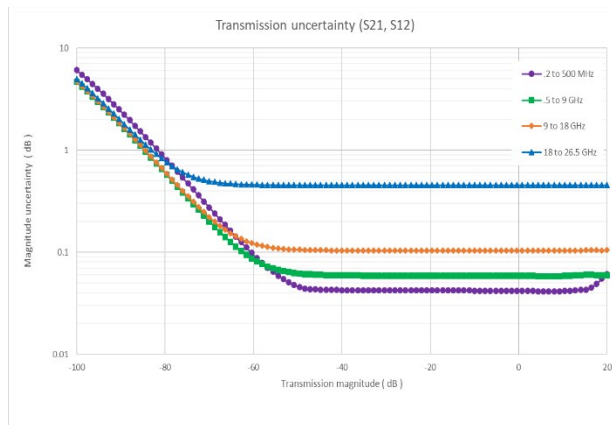

### Reflection uncertainty (S11, S22)

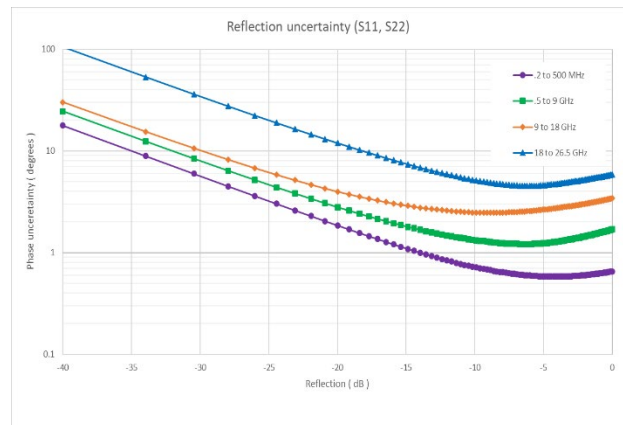
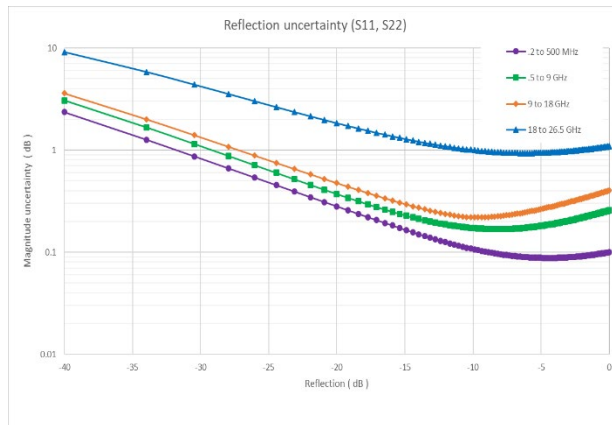

<sup>1</sup> When applied power exceeds -10 dBm, calibration results will be degraded from the performance indicated in this table.

<sup>2</sup> Load match and transmission tracking are typical values.



## Corrected Measurement Uncertainty (continued)

N9913/4/5/6/7/8B, N4690D ECal, Full 2-port Cal, DUT: Type-N, Spec

Corrected performance table calculated using uncertainties with a coverage factor of 2.

Corrected performance (dB) <sup>1</sup>	.2 to 10 MHz <sup>2</sup>	300 kHz to 2 MHz <sup>3</sup>	2 to 10 MHz <sup>3</sup>	10 to 500 MHz	.5 to 2 GHz	2 to 10 GHz	10 to 18 GHz
Directivity	45	30	40	45	45	40	38
Source match	40	28	35	40	43	40	35
Load match <sup>4</sup>	40	28	35	40	43	40	35
Reflection tracking	± 0.05	± 0.12	± 0.07	± 0.05	± 0.03	± 0.03	± 0.05
Transmission tracking <sup>4</sup>	± 0.05	± 0.12	± 0.07	± 0.05	± 0.03	± 0.03	± 0.05

Uncertainty plots<sup>5</sup>: power level of -15 dBm, 10 Hz IF bandwidth, no averaging, battery saver off, and 60-minute warm-up time. Includes uncertainties due to drift, noise, compression, and dynamic accuracy. Coverage factor of 1 applied to uncertainties, for ease of comparison with other industry handheld analyzers.

### Transmission uncertainty (S21, S12)

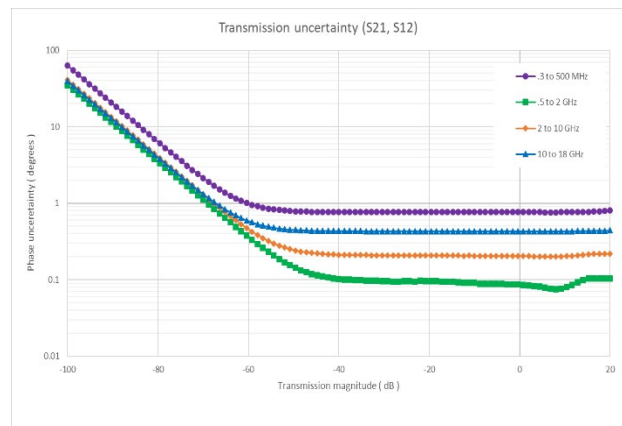
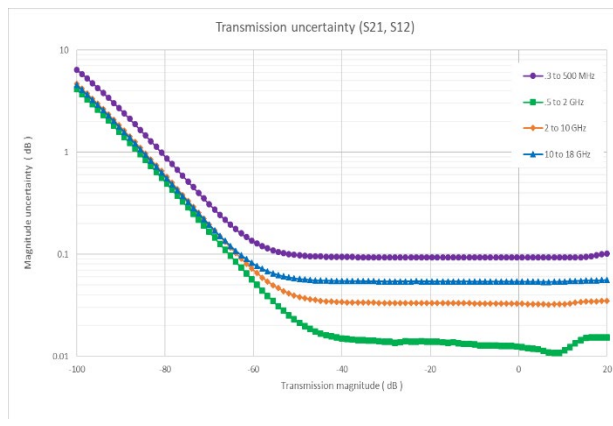

### Reflection uncertainty (S11, S22)

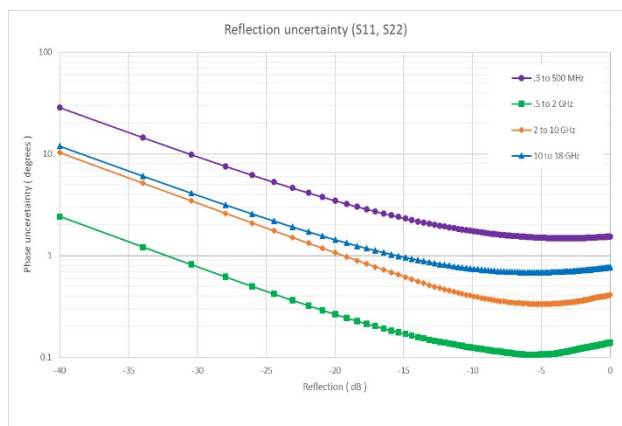
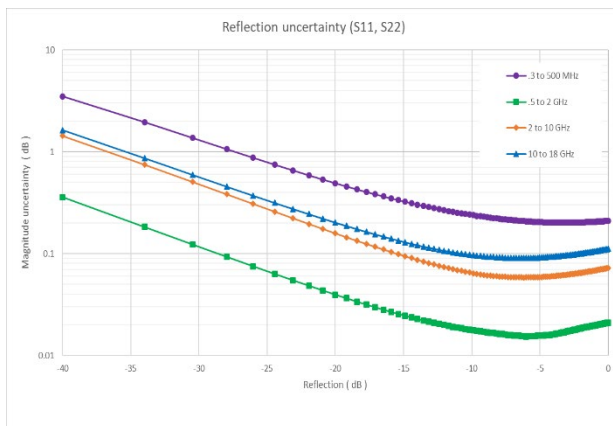

<sup>1</sup> When applied power exceeds -10 dBm, calibration results will be degraded from the performance indicated in this table.

<sup>2</sup> For N4690D ECal Option 0DC.

<sup>3</sup> For N4690D ECal Option 003.

<sup>4</sup> Load match and transmission tracking are typical values.

<sup>5</sup> Uncertainty plots generated with data from N4690B ECal modules.

## Corrected Measurement Uncertainty (continued)

N9913/4/5/6/7/8B, N4691D ECal, Full 2-port Cal, DUT: 3.5 mm, Spec

Corrected performance table calculated using uncertainties with a coverage factor of 2.

Corrected performance (dB) <sup>1</sup>	.2 to 10 MHz <sup>2</sup>	300 kHz to 2 MHz <sup>3</sup>	2 to 10 MHz <sup>3</sup>	10 to 500 MHz	.5 to 2 GHz	2 to 10 GHz	10 to 20 GHz	20 to 26.5 GHz
Directivity	46	31	41	46	47	46	43	41
Source match	41	29	36	41	47	45	42	40
Load match <sup>4</sup>	41	29	36	41	47	45	42	40
Reflection tracking	± 0.05	± 0.11	± 0.06	± 0.05	± 0.02	± 0.03	± 0.04	± 0.05
Transmission tracking <sup>4</sup>	± 0.05	± 0.11	± 0.06	± 0.05	± 0.02	± 0.03	± 0.04	± 0.05

Uncertainty plots<sup>5</sup>: power level of -15 dBm, 10 Hz IF bandwidth, no averaging, battery saver off, and 60-minute warm-up time. Includes uncertainties due to drift, noise, compression, and dynamic accuracy. Coverage factor of 1 applied to uncertainties, for ease of comparison with other industry handheld analyzers.

### Transmission uncertainty (S21, S12)

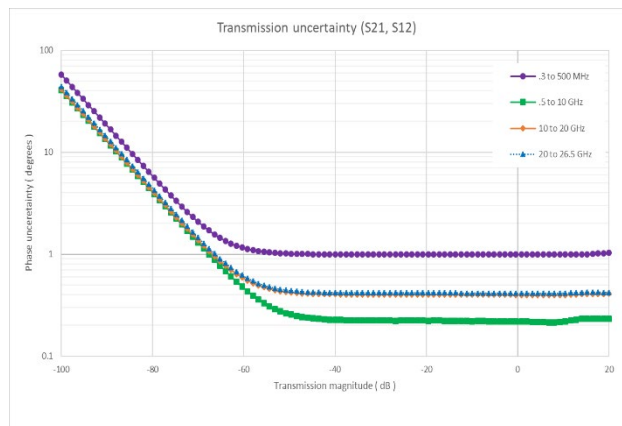
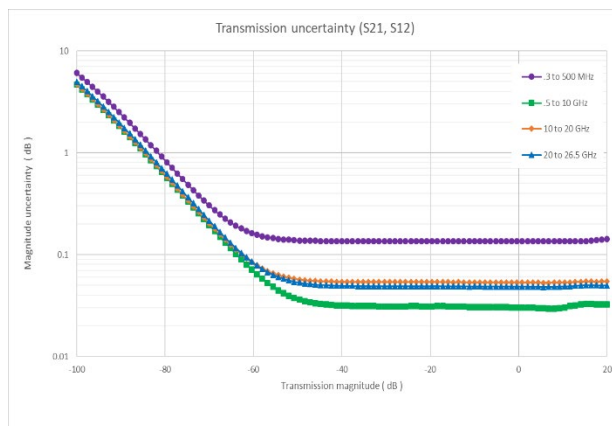

### Reflection uncertainty (S11, S22)

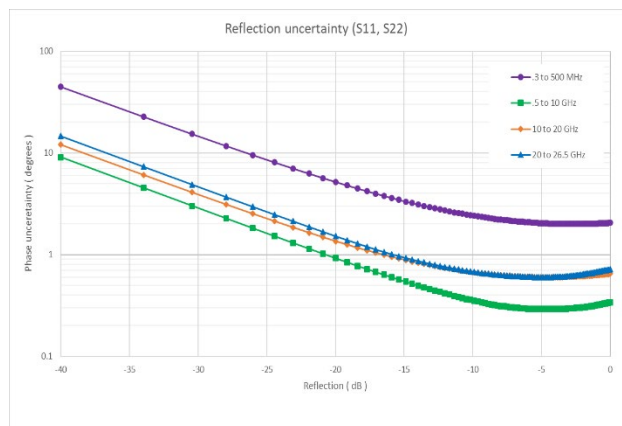
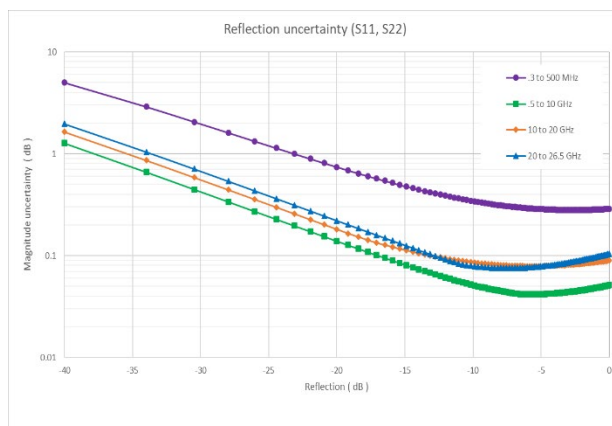

<sup>1</sup> When applied power exceeds -10 dBm, calibration results will be degraded from the performance indicated in this table.

<sup>2</sup> For N4691D ECal Option ODC.

<sup>3</sup> For N4691D ECal Option 003.

<sup>4</sup> Load match and transmission tracking are typical values.

<sup>5</sup> Uncertainty plots generated with data from N4691B ECal modules.



## Corrected Measurement Uncertainty (continued)

N9950/1/2B, 85056D, 85563A, or 85564A, Full 2-port Cal, DUT: 2.4 mm, Spec

Corrected performance table calculated using uncertainties with a coverage factor of 2.

Corrected performance (dB)	0.3 MHz to 4 GHz	4 to 20 GHz	20 to 26.5 GHz	26.5 to 50 GHz
Directivity	42	34	26	26
Source match	40	30	24	23
Load match <sup>1</sup>	38	29	26	22
Reflection tracking	± 0.029	± 0.029	± 0.080	± 0.075
Transmission tracking <sup>1</sup>	± 0.033	± 0.086	± 0.084	± 0.153

Uncertainty plots: power level of -15 dBm, 10 Hz IF bandwidth, no averaging, battery saver off, and 60-minute warm-up time. Includes uncertainties due to drift, noise, compression, and dynamic accuracy. Coverage factor of 1 applied to uncertainties, for ease of comparison with other industry handheld analyzers.

### Transmission uncertainty (S21, S12)

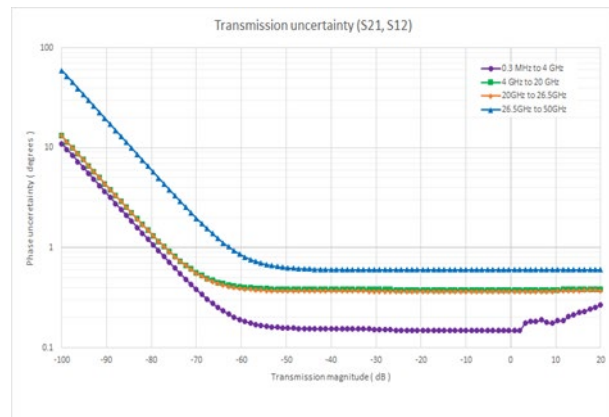
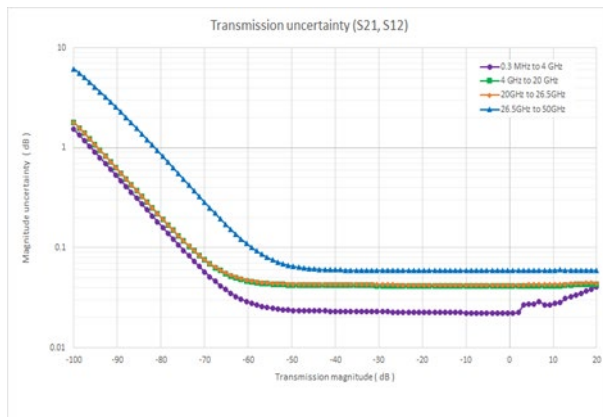

### Reflection uncertainty (S11, S22)

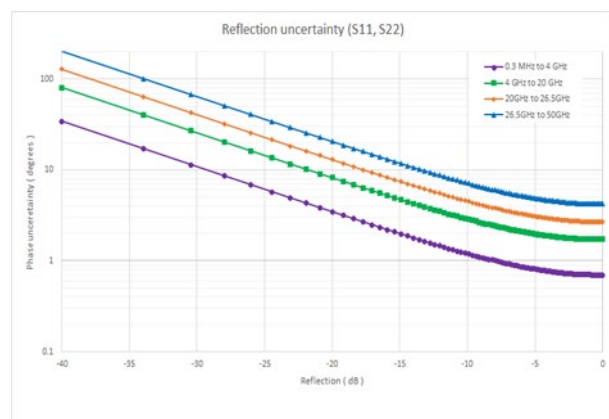
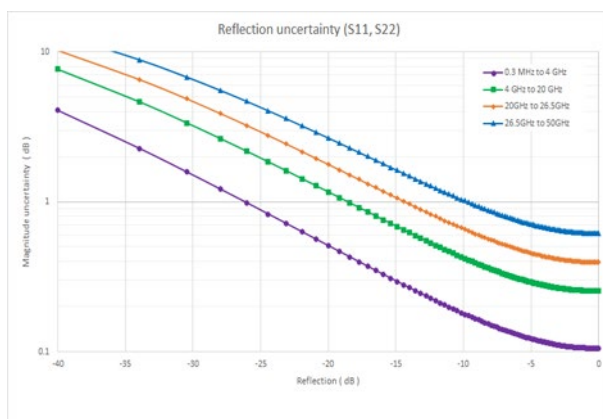

<sup>1</sup> Load match and transmission tracking are typical values.

## Corrected Measurement Uncertainty (continued)

N9950/1/2B, 85561A, Full 2-port Cal, DUT: 2.92 mm, Spec

Corrected performance table calculated using uncertainties with a coverage factor of 2.

Corrected performance (dB)	0.3 MHz to 4 GHz	4 to 20 GHz	20 to 26.5 GHz	26.5 to 40 GHz
Directivity	36	26	24	20
Source match	31	25	23	19
Load match <sup>1</sup>	32	24	22	19
Reflection tracking	± 0.001	± 0.041	± 0.049	± 0.11
Transmission tracking <sup>1</sup>	± 0.16	± 0.30	± 0.43	± 0.52

Uncertainty plots: power level of -15 dBm, 10 Hz IF bandwidth, no averaging, battery saver off, and 60-minute warm-up time. Includes uncertainties due to drift, noise, compression, and dynamic accuracy. Coverage factor of 1 applied to uncertainties, for ease of comparison with other industry handheld analyzers.

### Transmission uncertainty (S21, S12)

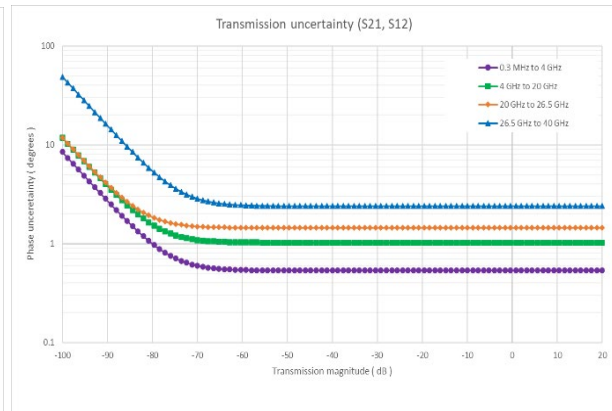
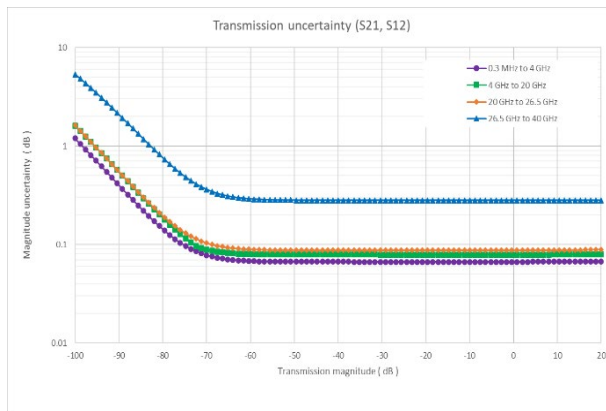

### Reflection uncertainty (S11, S22)

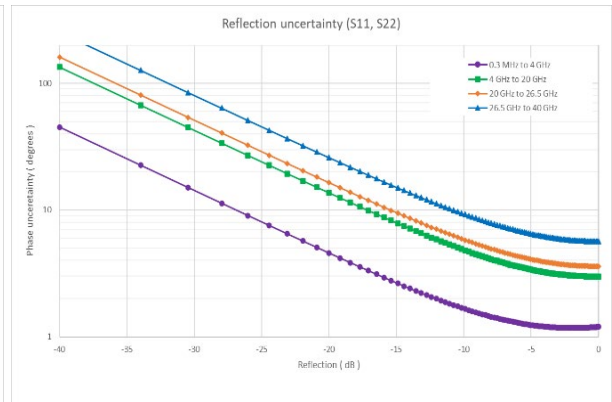
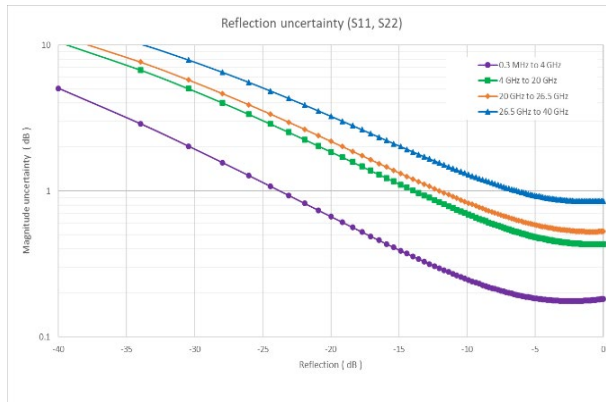

<sup>1</sup> Load match and transmission tracking are typical values.

## Corrected Measurement Uncertainty (continued)

N9950/1/2B, 85562A, Full 2-port Cal, DUT: 2.92 mm, Spec

Corrected performance table calculated using uncertainties with a coverage factor of 2.

Corrected performance (dB)	0.3 MHz to 4 GHz	4 to 20 GHz	20 to 26.5 GHz	26.5 to 40 GHz
Directivity	36	28	28	25
Source match	34	27	25	23
Load match <sup>1</sup>	32	26	23	22
Reflection tracking	± 0.006	± 0.026	± 0.062	± 0.13
Transmission tracking <sup>1</sup>	± 0.16	± 0.24	± 0.42	± 0.48

Uncertainty plots: power level of -15 dBm, 10 Hz IF bandwidth, no averaging, battery saver off, and 60-minute warm-up time. Includes uncertainties due to drift, noise, compression, and dynamic accuracy. Coverage factor of 1 applied to uncertainties, for ease of comparison with other industry handheld analyzers.

### Transmission uncertainty (S21, S12)

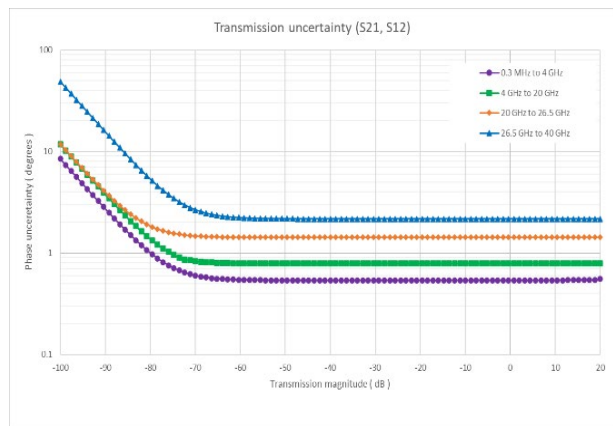
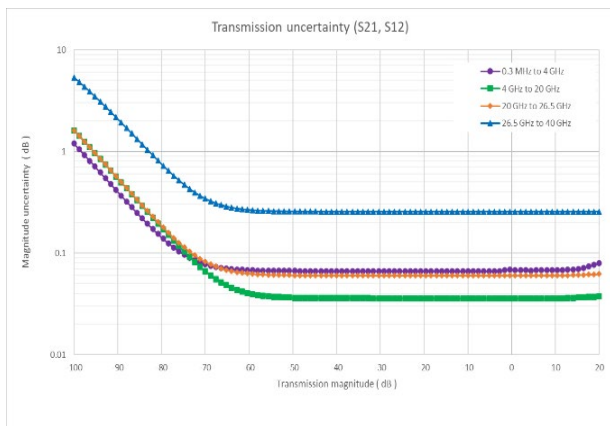

### Reflection uncertainty (S11, S22)

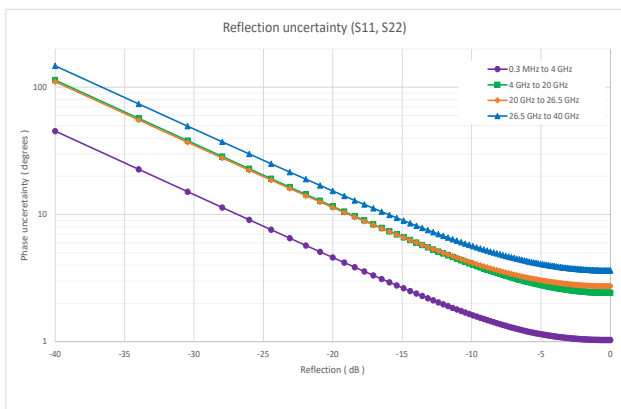
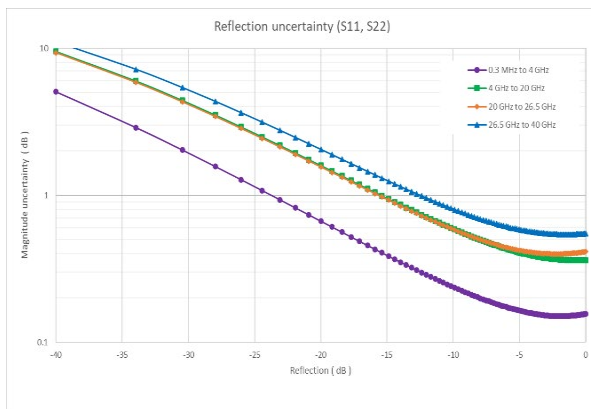

<sup>1</sup> Load match and transmission tracking are typical values.

## Corrected Measurement Uncertainty (continued)

N9950/1/2B, BN 534913, Full 2-port Cal, DUT: 2.92 mm, Spec

Corrected performance table calculated using uncertainties with a coverage factor of 2.

Corrected performance (dB)	0.3 MHz to 4 GHz	4 to 20 GHz	20 to 26.5 GHz	26.5 to 44 GHz
Directivity	34	30	25	19
Source match	34	26	23	18
Load match <sup>1</sup>	31	26	22	17
Reflection tracking	± 0.006	± 0.026	± 0.086	± 0.25
Transmission tracking <sup>1</sup>	± 0.22	± 0.33	± 0.41	± 0.54

Uncertainty plots: power level of -15 dBm, 10 Hz IF bandwidth, no averaging, battery saver off, and 60-minute warm-up time. Includes uncertainties due to drift, noise, compression, and dynamic accuracy. Coverage factor of 1 applied to uncertainties, for ease of comparison with other industry handheld analyzers.

### Transmission uncertainty (S21, S12)

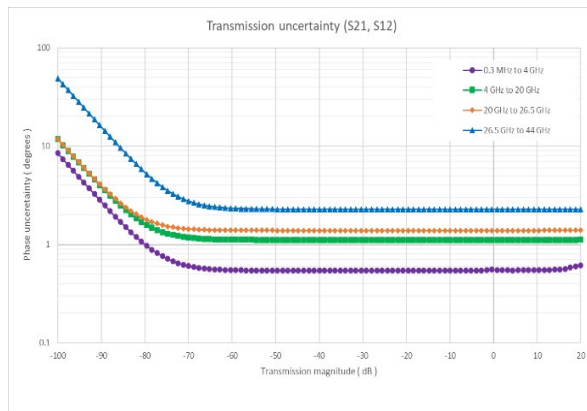
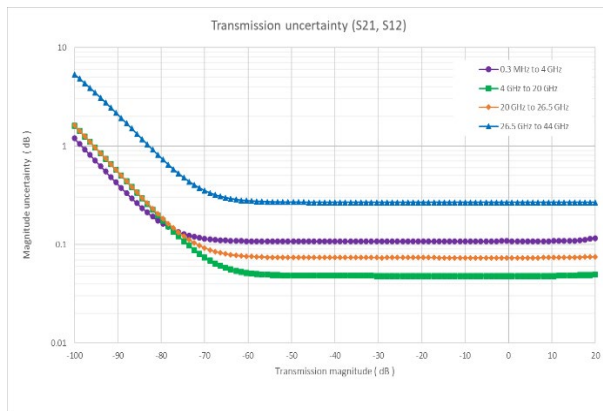

### Reflection uncertainty (S11, S22)

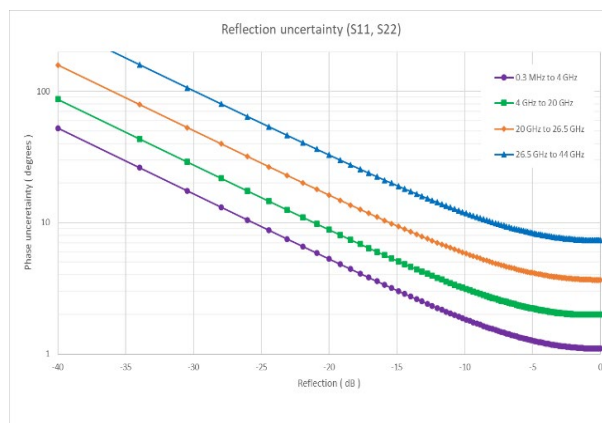
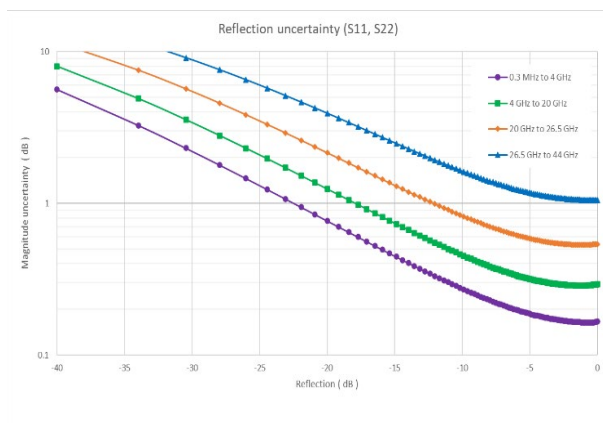

<sup>1</sup> Load match and transmission tracking are typical values.

## Corrected Measurement Uncertainty (continued)

N9950/1/2B, BN 534914, Full 2-port Cal, DUT: 2.92 mm, Spec

Corrected performance table calculated using uncertainties with a coverage factor of 2.

Corrected performance (dB)	0.3 MHz to 4 GHz	4 to 20 GHz	20 to 26.5 GHz	26.5 to 44 GHz
Directivity	30	29	25	18
Source match	29	28	23	18
Load match <sup>1</sup>	29	25	22	18
Reflection tracking	± 0.005	± 0.042	± 0.072	± 0.24
Transmission tracking <sup>1</sup>	± 0.18	± 0.37	± 0.43	± 0.47

Uncertainty plots: power level of -15 dBm, 10 Hz IF bandwidth, no averaging, battery saver off, and 60-minute warm-up time. Includes uncertainties due to drift, noise, compression, and dynamic accuracy. Coverage factor of 1 applied to uncertainties, for ease of comparison with other industry handheld analyzers.

### Transmission uncertainty (S21, S12)

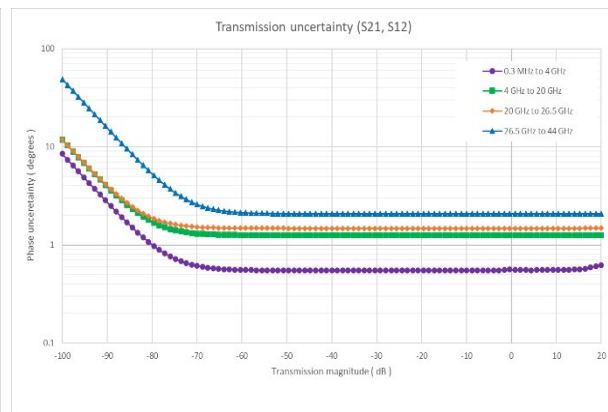
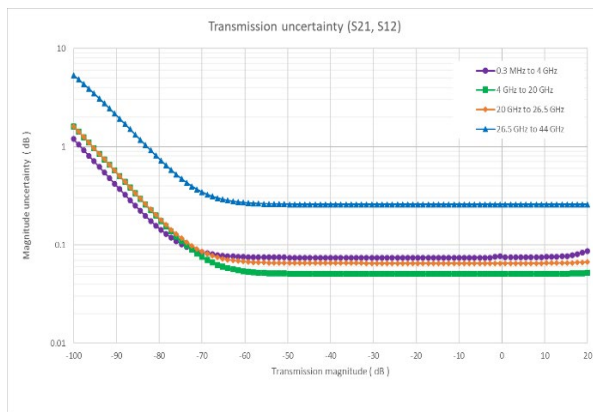

### Reflection uncertainty (S11, S22)

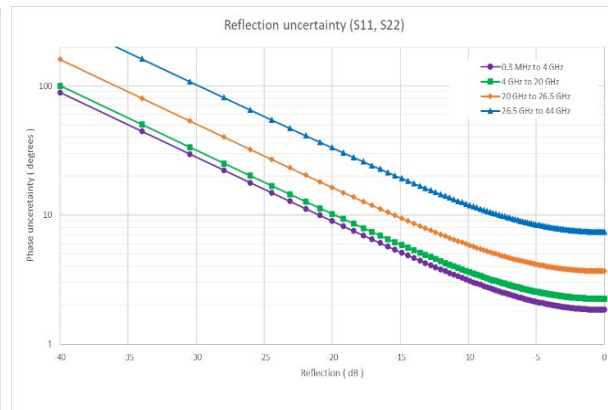
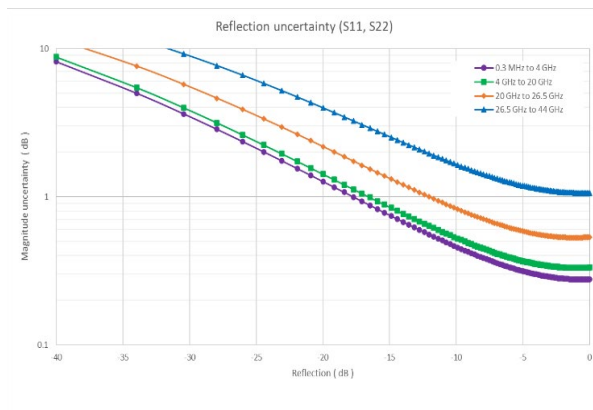

<sup>1</sup> Load match and transmission tracking are typical values.

## Corrected Measurement Uncertainty (continued)

N9950/1/2B, N4692D ECal Option 0DC, Full 2-port Cal, DUT: 2.92 mm, Spec

Corrected performance table calculated using uncertainties with a coverage factor of 2.

Corrected performance (dB) <sup>1</sup>	0.3 MHz to 4 GHz	4 to 20 GHz	20 to 26.5 GHz	26.5 to 40 GHz
Directivity	40	38	35	32
Source match	38	35	30	29
Load match <sup>2</sup>	30	27	27	26
Reflection tracking	± 0.1	± 0.1	± 0.10	± 0.12
Transmission tracking <sup>2</sup>	± 0.2	± 0.25	± 0.25	± 0.29

Uncertainty plots: power level of -15 dBm, 10 Hz IF bandwidth, no averaging, battery saver off, and 60-minute warm-up time. Includes uncertainties due to drift, noise, compression, and dynamic accuracy. Coverage factor of 1 applied to uncertainties, for ease of comparison with other industry handheld analyzers.

### Transmission uncertainty (S21, S12) – N4692D ECal Option 0DC

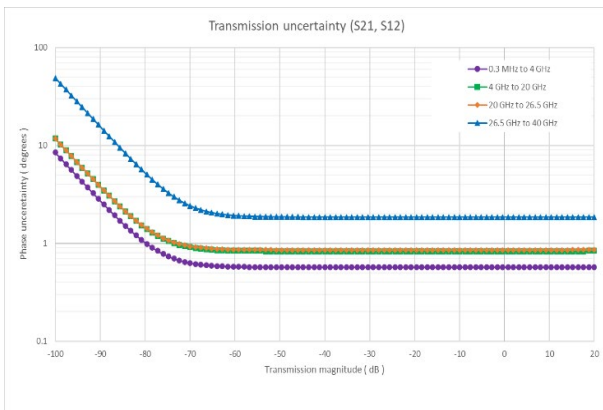
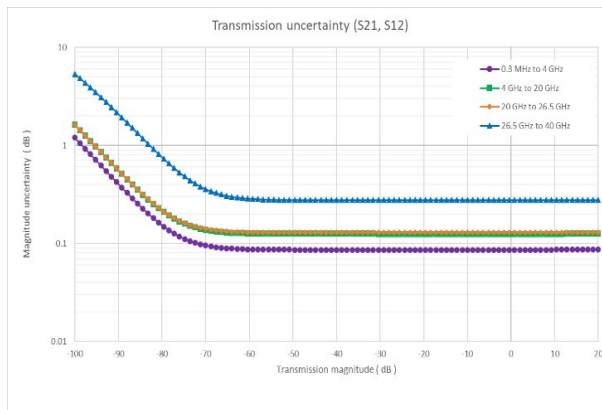

### Reflection uncertainty (S11, S22) – N4692D ECal Option 0DC

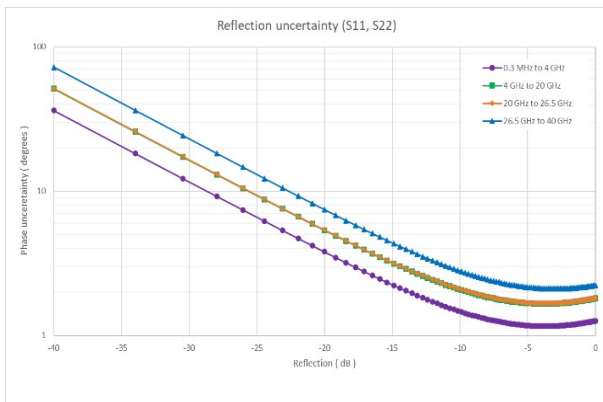
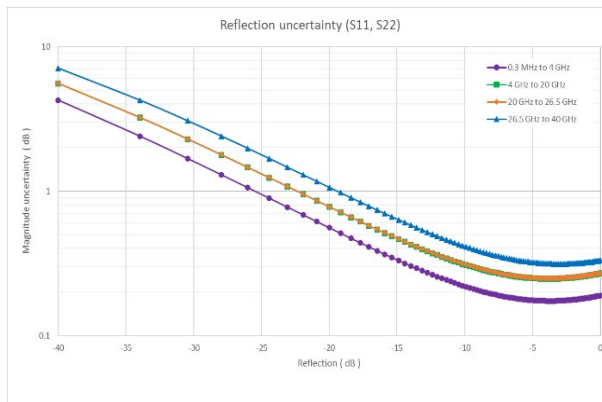

<sup>1</sup> When applied power exceeds -10 dBm, calibration results will be degraded from the performance indicated in this table.

<sup>2</sup> Load match and transmission tracking are typical values.



## Corrected Measurement Uncertainty (continued)

N9950/1/2B, N4692D ECal Option 010, Full 2-port Cal, DUT: 2.92 mm, Spec

Corrected performance table calculated using uncertainties with a coverage factor of 2.

Corrected performance (dB) <sup>1</sup>	10 MHz to 4 GHz	4 to 20 GHz	20 to 26.5 GHz	26.5 to 40 GHz
Directivity	29	38	35	32
Source match	29	35	30	29
Load match <sup>2</sup>	24	27	27	26
Reflection tracking	± 0.18	± 0.1	± 0.10	± 0.12
Transmission tracking <sup>2</sup>	± 0.34	± 0.25	± 0.25	± 0.29

Uncertainty plots: power level of -15 dBm, 10 Hz IF bandwidth, no averaging, battery saver off, and 60-minute warm-up time. Includes uncertainties due to drift, noise, compression, and dynamic accuracy. Coverage factor of 1 applied to uncertainties, for ease of comparison with other industry handheld analyzers.

### Transmission uncertainty (S21, S12) – N4692D ECal Option 010

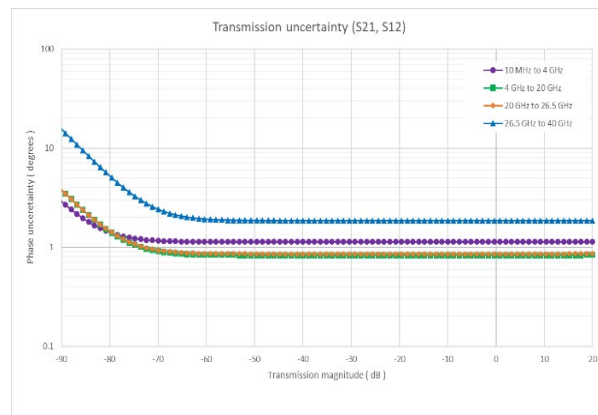
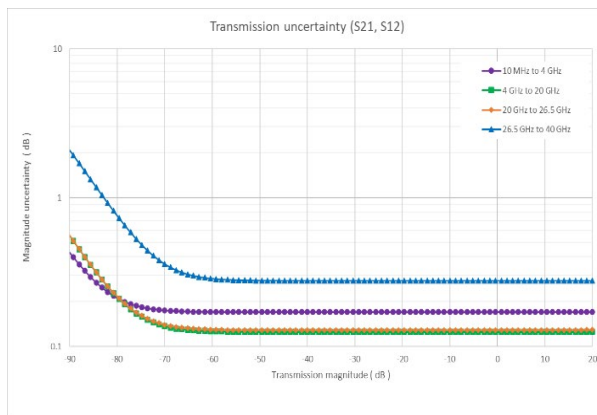

### Reflection uncertainty (S11, S22) – N4692D ECal Option 010

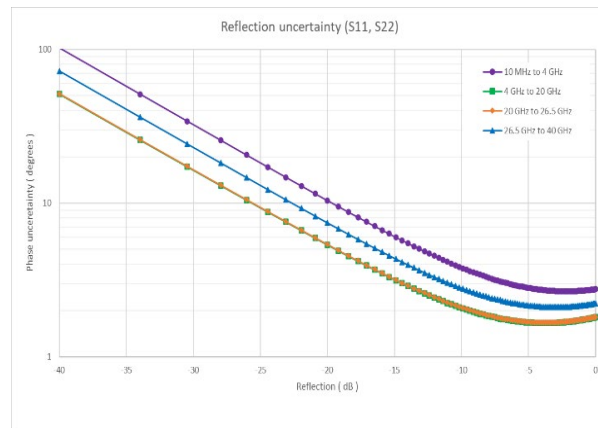
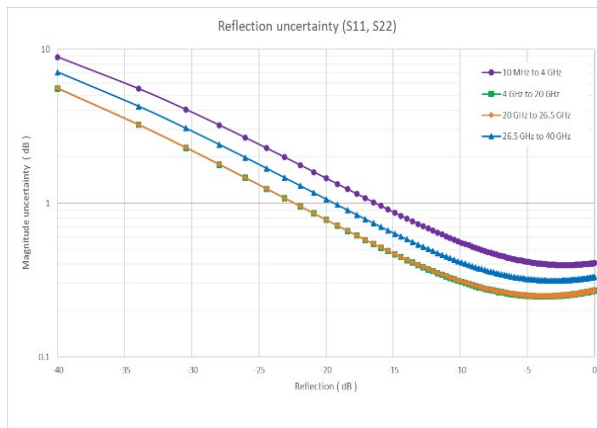

<sup>1</sup> When applied power exceeds -10 dBm, calibration results will be degraded from the performance indicated in this table.

<sup>2</sup> Load match and transmission tracking are typical values.

## Corrected Measurement Uncertainty (continued)

N9950/1/2B, N4693D ECal Option 0DC, Full 2-port Cal, DUT: 2.4 mm, Spec

Corrected performance table calculated using uncertainties with a coverage factor of 2.

Corrected performance (dB) <sup>1</sup>	.3 MHz to 4 GHz	4 to 20 GHz	20 to 26.5 GHz	26.5 to 50 GHz
Directivity	40	44	38	34
Source match	38	37	35	32
Load match <sup>2</sup>	34	32	32	29
Reflection tracking	± 0.05	± 0.05	± 0.06	± 0.08
Transmission tracking <sup>2</sup>	± 0.077	± 0.102	± 0.102	± 0.162

Uncertainty plots: power level of -15 dBm, 10 Hz IF bandwidth, no averaging, battery saver off, and 60-minute warm-up time. Includes uncertainties due to drift, noise, compression, and dynamic accuracy. Coverage factor of 1 applied to uncertainties, for ease of comparison with other industry handheld analyzers.

### Transmission uncertainty (S21, S12) – N4693D ECal Option 0DC

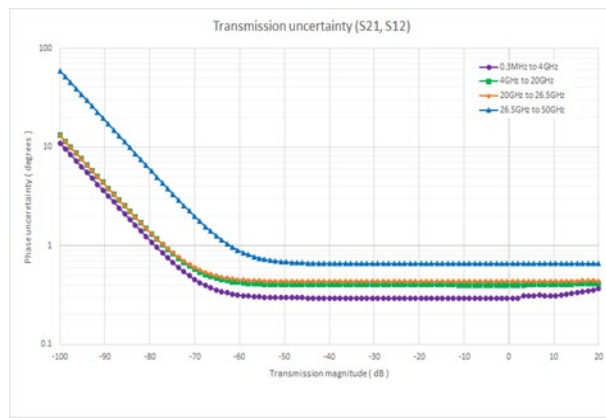
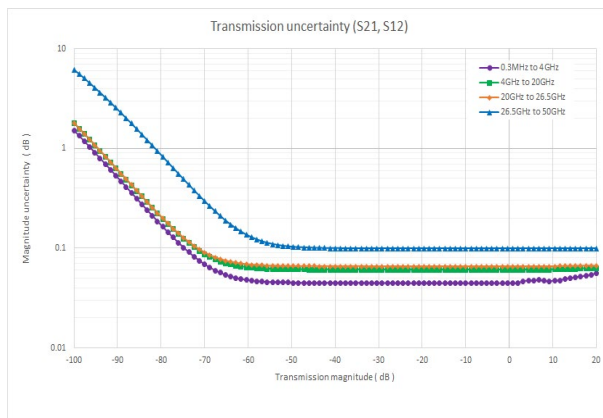

### Reflection uncertainty (S11, S22) – N4693D ECal Option 0DC

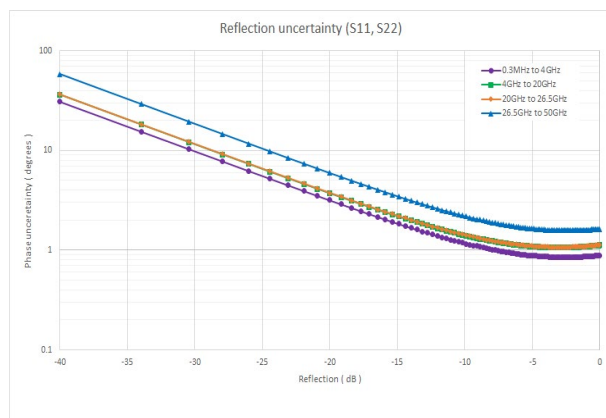
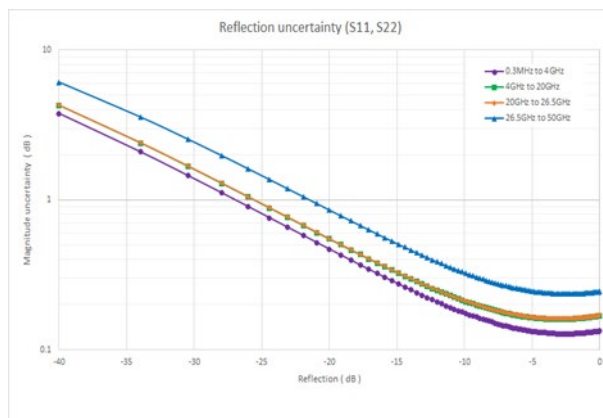

<sup>1</sup> When applied power exceeds -10 dBm, calibration results will be degraded from the performance indicated in this table.

<sup>2</sup> Load match and transmission tracking are typical values.



## Corrected Measurement Uncertainty (continued)

N9950/1/2B, N4693D ECal Option 010, Full 2-port Cal, DUT: 2.4 mm, Spec

Corrected performance table calculated using uncertainties with a coverage factor of 2.

Corrected performance (dB) <sup>1</sup>	10 MHz to 4 GHz	4 to 20 GHz	20 to 26.5 GHz	26.5 to 50 GHz
Directivity	27	44	38	34
Source match	25	37	35	32
Load match <sup>2</sup>	23	32	32	29
Reflection tracking	± 0.05	± 0.05	± 0.06	± 0.08
Transmission tracking <sup>2</sup>	± 0.307	± 0.102	± 0.102	± 0.162

Uncertainty plots: power level of -15 dBm, 10 Hz IF bandwidth, no averaging, battery saver off, and 60-minute warm-up time. Includes uncertainties due to drift, noise, compression, and dynamic accuracy. Coverage factor of 1 applied to uncertainties, for ease of comparison with other industry handheld analyzers.

### Transmission uncertainty (S21, S12) – N4693D ECal Option 010

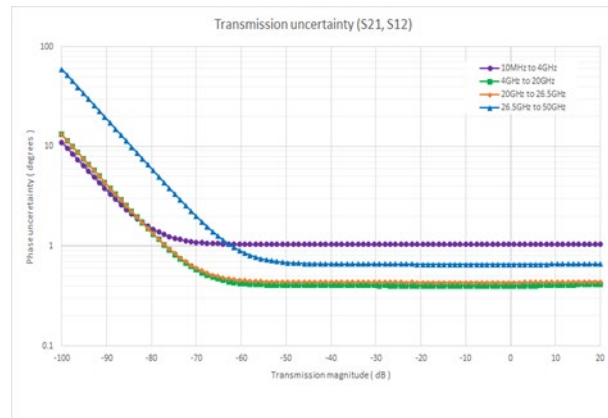
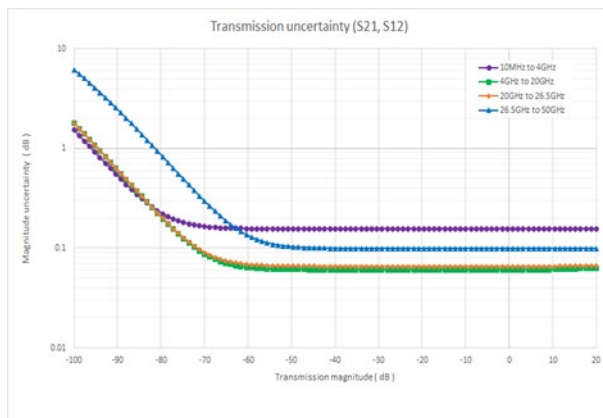

### Reflection uncertainty (S11, S22) – N4693D ECal Option 010

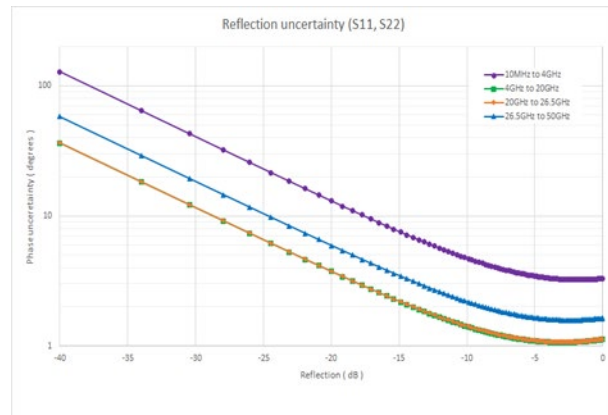
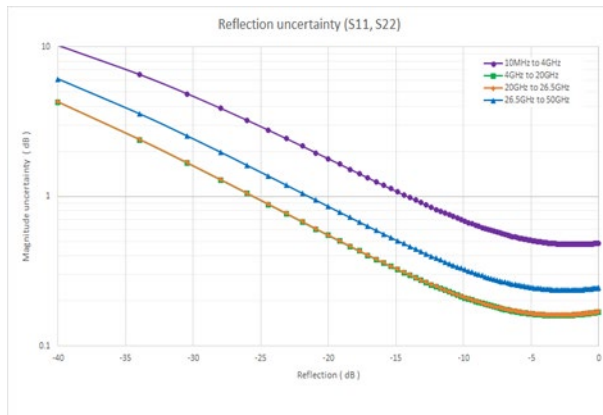

<sup>1</sup> When applied power exceeds -10 dBm, calibration results will be degraded from the performance indicated in this table.

<sup>2</sup> Load match and transmission tracking are typical values.

## Corrected Measurement Uncertainty (continued)

N9953B, 85058E, Full 2-port Cal, DUT: 1.85 mm, Spec

Corrected performance table calculated using uncertainties with a coverage factor of 2.

Corrected performance (dB)	0.3 MHz to 4 GHz	4 to 26.5 GHz	26.5 to 50 GHz	50 to 54 GHz
Directivity	30	30	28	28
Source match	28	26	24	24
Load match <sup>1</sup>	30	27	23	23
Reflection tracking	± 0.021	± 0.028	± 0.052	± 0.052
Transmission tracking <sup>1</sup>	± 0.155	± 0.177	± 0.291	± 0.310

Uncertainty plots: power level of -15 dBm, 10 Hz IF bandwidth, no averaging, battery saver off, and 60-minute warm-up time. Includes uncertainties due to drift, noise, compression, and dynamic accuracy. Coverage factor of 1 applied to uncertainties, for ease of comparison with other industry handheld analyzers.

### Transmission uncertainty (S21, S12)

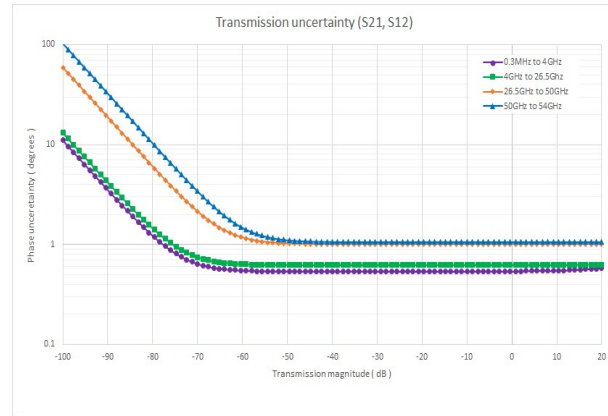
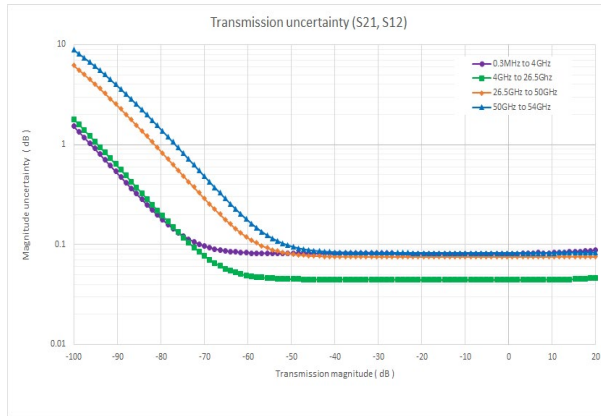

### Reflection uncertainty (S11, S22)

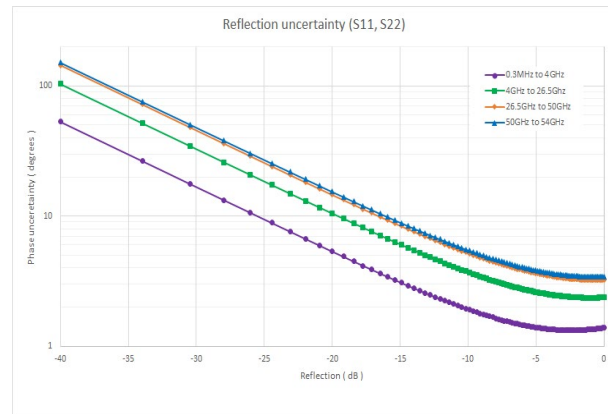
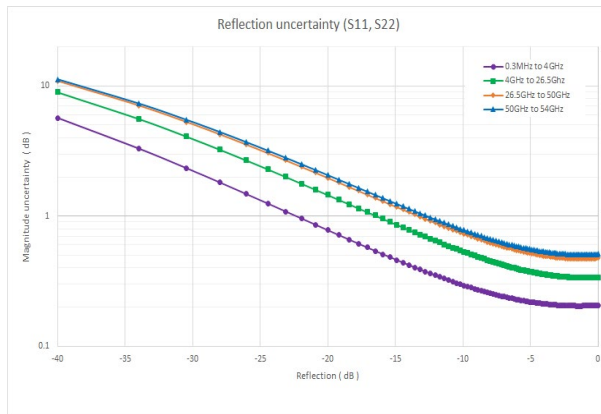

<sup>1</sup> Load match and transmission tracking are typical values.

## Corrected Measurement Uncertainty (continued)

N9953B, N4694D 0DC ECal, Full 2-port Cal, DUT: 1.85 mm, Spec

Corrected performance table calculated using uncertainties with a coverage factor of 2.

Corrected performance (dB) <sup>1</sup>	0.3 MHz to 4 GHz	4 to 26.5 GHz	26.5 to 50 GHz	50 to 54 GHz
Directivity	27	41	38	35
Source match	23	38	33	26
Load match <sup>2</sup>	38	29	26	22
Reflection tracking	± 0.080	± 0.040	± 0.080	± 0.120
Transmission tracking <sup>2</sup>	± 0.092	± 0.094	± 0.141	± 0.184

Uncertainty plots: power level of -15 dBm, 10 Hz IF bandwidth, no averaging, battery saver off, and 60-minute warm-up time. Includes uncertainties due to drift, noise, compression, and dynamic accuracy. Coverage factor of 1 applied to uncertainties, for ease of comparison with other industry handheld analyzers.

### Transmission uncertainty (S21, S12) – N4694D ECal Option 0DC

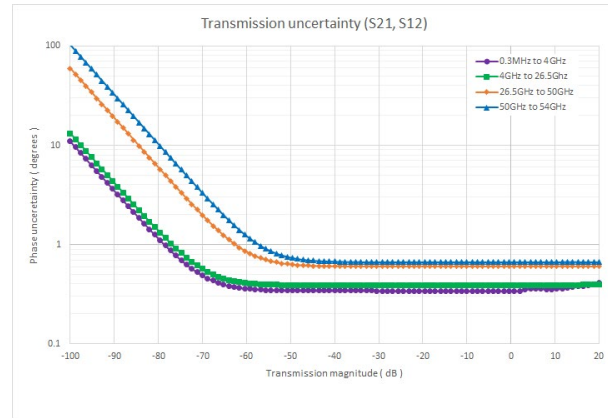
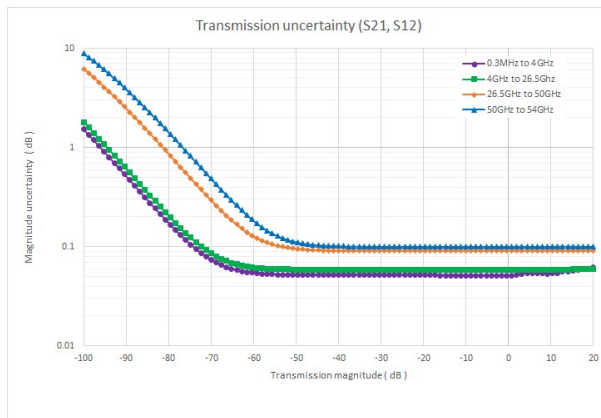

### Reflection uncertainty (S11, S22) – N4693D ECal Option 0DC

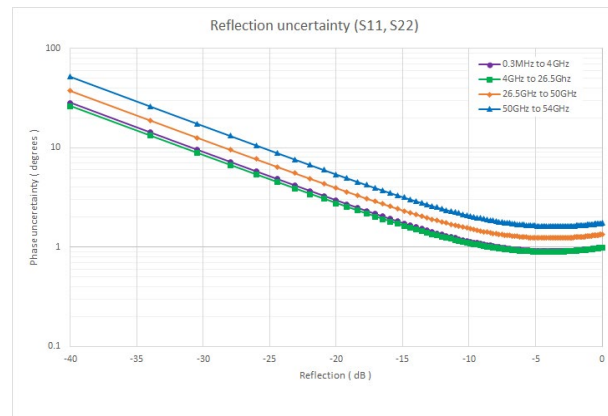

<sup>1</sup> When applied power exceeds -10 dBm, calibration results will be degraded from the performance indicated in this table.

<sup>2</sup> Load match and transmission tracking are typical values.

## Corrected Measurement Uncertainty (continued)

N9953B, N4694D 010 ECal, Full 2-port Cal, DUT: 1.85 mm, Spec

Corrected performance table calculated using uncertainties with a coverage factor of 2.

Corrected performance (dB) <sup>1</sup>	10 MHz to 4 GHz	4 to 26.5 GHz	26.5 to 50 GHz	50 to 54 GHz
Directivity	27	41	38	35
Source match	23	38	33	26
Load match <sup>2</sup>	22	33	30	28
Reflection tracking	± 0.080	± 0.040	± 0.080	± 0.120
Transmission tracking <sup>2</sup>	± 0.354	± 0.094	± 0.141	± 0.184

Uncertainty plots: power level of -15 dBm, 10 Hz IF bandwidth, no averaging, battery saver off, and 60-minute warm-up time. Includes uncertainties due to drift, noise, compression, and dynamic accuracy. Coverage factor of 1 applied to uncertainties, for ease of comparison with other industry handheld analyzers.

### Transmission uncertainty (S21, S12) – N4694D ECal Option 010

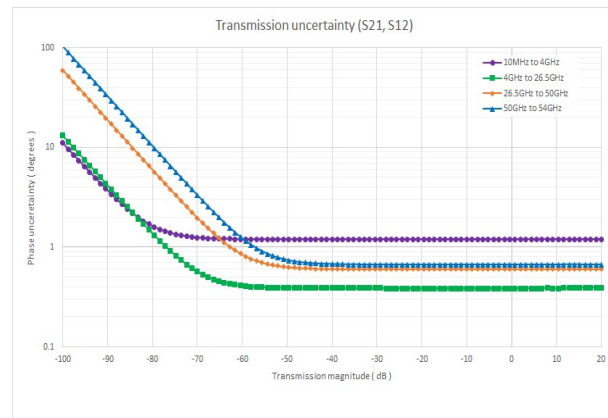
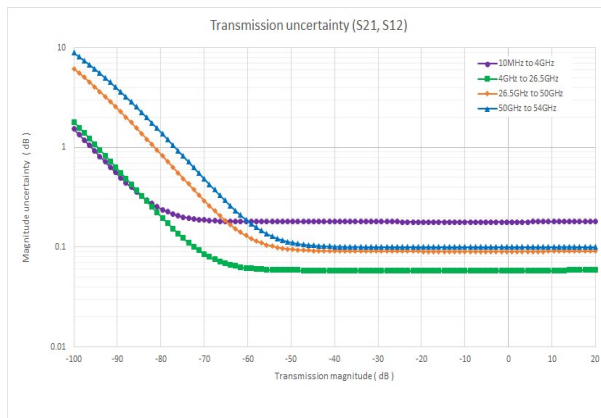

### Reflection uncertainty (S11, S22) – N4693D ECal Option 010

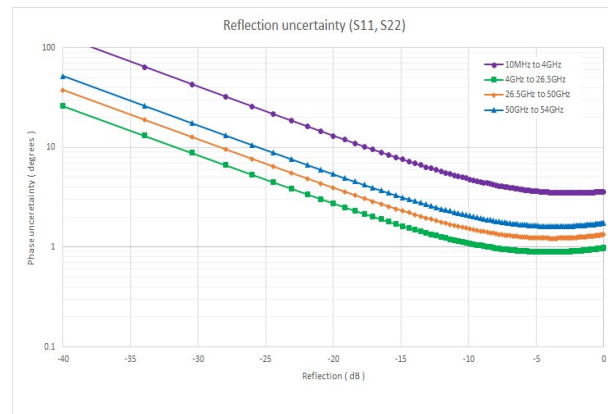
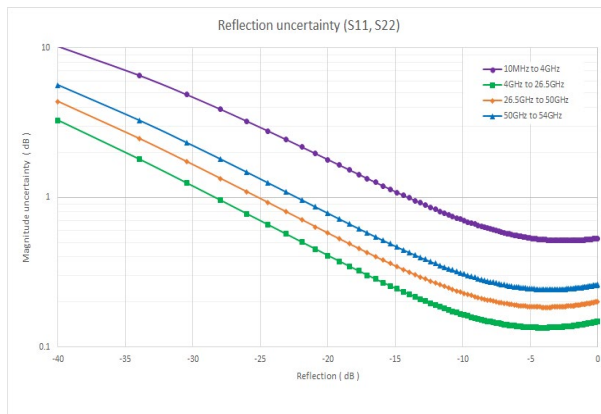

<sup>1</sup> When applied power exceeds -10 dBm, calibration results will be degraded from the performance indicated in this table.

<sup>2</sup> Load match and transmission tracking are typical values.

The performance listed in TDR cable measurements, VNA time domain, mixed-mode S-parameters and vector voltmeter sections applies to the capabilities available in the following models:

FieldFox RF & microwave (combination) analyzers: N9913B, N9914B, N9915B, N9916B, N9917B, N9918B,  
N9950B, N9951B, N9952B

See [FieldFox Configuration Guide](#) for option information. Many capabilities listed in this Data Sheet require options.

## TDR Cable Measurements (Option 215)

The TDR cable option adds time domain reflectometry (TDR) measurements to FieldFox's CAT mode. FieldFox's TDR measurements are based on an inverse Fourier transform of the frequency-domain data. TDR measurements are useful in not only identifying the location of faults along cables, but also the nature of the fault. Resistive, inductive and capacitive faults will each have a different response. These differences help engineers and technicians' trouble-shoot line faults.

Measurements: TDR (linear rho), TDR (ohm), TDR & DTF

Y-axis: linear (rho) or impedance (ohm)

X-axis: distance (meters or feet)

## VNA Time Domain (Option 010)

In time-domain mode, FieldFox computes the inverse Fourier transform of the frequency-domain data to display reflection or transmission coefficients versus time.

Setup parameters	
Time	Start, stop, center, span
Gating	Start, stop, center, span, and on/off
Numbers of points, velocity vector, line loss, window shape, independent control for all four traces	
Time stimulus modes	
Low-pass step	Low-pass step is similar to a traditional time domain reflectometer (TDR) stimulus waveform. It is used to measure low-pass devices. The frequency-domain data should extend from DC (extrapolated value) to a higher value.
Low-pass impulse	Low-pass impulse response is used to measure low-pass devices.
Bandpass impulse	The bandpass impulse simulates a pulsed RF signal and is used to measure the time domain response of band-limited devices.
Windows	
The windowing function can be used to filter the frequency domain data and thereby reduce overshoot and ringing in the time domain response.	
Windows	Minimum, medium and maximum, manual entry of Kaiser Beta and impulse width.
Gating	
The gating function can be used to selectively remove reflection or transmission time domain responses. In converting back to the frequency domain, the effects of the responses outside the gate are removed. The results can be viewed with gating on and off, using two traces.	
Gate types	Notch, bandpass
Gate shapes	Maximum, wide, normal, minimum

## Mixed-Mode S-Parameters (Option 212)

Mixed-mode S-parameters are also known as balanced measurements.

Measurements	
Sc <sub>c</sub> 11	Common mode reflection
S <sub>d</sub> d11	Differential mode reflection
Sc <sub>d</sub> 11	Differential mode stimulus, common mode response
S <sub>d</sub> c11	Common mode stimulus, differential mode response

FieldFox's mixed-mode S-parameter measurements require the use of the default factory calibration or a user 2-port calibration. So, the FieldFox analyzer must be equipped with 2-port measurement functionality to measure mixed-mode S-parameters. Mixed-mode S-parameters are an extension of the VNA capabilities.

## Vector Voltmeter (VVM) (Option 308)

With vector voltmeter mode, you can characterize the difference between two measurements easily. The zeroing function allows you to create a reference signal and characterize the difference between two device measurements. The results are shown on a large display in digital format.

	Models	Frequency range
N991xB	N9913B	30 kHz to 4 GHz
	N9914B	30 kHz to 6.5 GHz
	N9915B	30 kHz to 9 GHz
	N9916B	30 kHz to 14 GHz
	N9917B	30 kHz to 18 GHz
	N9918B	30 kHz to 26.5 GHz
N995xB	N9950B	300 kHz to 32 GHz
	N9951B	300 kHz to 44 GHz
	N9952B	300 kHz to 50 GHz
	N9953B	300 kHz to 54 GHz

Setup parameters	
1-port cable trimming	Reflection (S11 or S22 measurement), magnitude and phase
2-port transmission	Transmission or S21 measurement, magnitude, and phase
A/B and B/A	Ratio of two receivers or channels, magnitude, and phase – Need an external signal generator for the A/B or B/A measurement
	Frequency (one CW frequency point)
	IF bandwidth: 10 Hz to 100 kHz or 3 Hz to 30 kHz
	Output power: Low, high, manual

## Ratio accuracy (A/B and B/A)

Must zero before measuring DUT. Recommend using a high-quality power splitter or 6 dB attenuators to minimize uncertainty due to mismatch.

	Frequency	Nominal (dB)
N991xB	100 kHz to 2 GHz	± 0.2
N995xB	300 kHz to 2 GHz	± 0.2



## Spectrum Analyzer (Option 233 on Combination Analyzers)

The performance listed in this section applies to the spectrum analyzer capabilities available in the following models:

FieldFox RF & microwave (combination) analyzers:	N9913B, N9914B, N9915B, N9916B, N9917B, N9918B
FieldFox RF & microwave signal analyzers:	N9933B, N9934B, N9935B, N9936B, N9937B, N9938B
FieldFox microwave (combination) analyzers:	N9950B, N9951B, N9952B, N9953B
FieldFox microwave signal analyzers:	N9960B, N9961B, N9962B, N9963B

See [FieldFox Configuration Guide](#) for option information. Many capabilities listed in this Data Sheet require options.

### Frequency and time specifications

	Models	Frequency range <sup>1</sup>	
<b>N991xB, N993xB</b>	N9913B, N9933B	9 kHz to 4 GHz	Usable to 5 kHz
	N9914B, N9934B	9 kHz to 6.5 GHz	Usable to 5 kHz
	N9915B, N9935B	9 kHz to 9 GHz	Usable to 5 kHz
	N9916B, N9936B	9 kHz to 14 GHz	Usable to 5 kHz
	N9917B, N9937B	9 kHz to 18 GHz	Usable to 5 kHz
	N9918B, N9938B	9 kHz to 26.5 GHz	Usable to 5 kHz
<b>N995xB, N996xB</b>	N9950B, N9960B	9 kHz to 32 GHz	Usable to 5 kHz
	N9951B, N9961B	9 kHz to 44 GHz	Usable to 5 kHz
	N9952B, N9962B	9 kHz to 50 GHz	Usable to 5 kHz
	N9953B, N9963B	9 kHz to 54 GHz	Usable to 5 kHz

#### Frequency reference, -10 to 55°C

Accuracy	$\pm 0.9$ ppm (spec) + aging
	$\pm 0.5$ ppm (typical) + aging
Accuracy, when locked to GPS	$\pm 0.01$ ppm (spec)
Accuracy, when GPS antenna is disconnected	$\pm 0.4$ ppm (nominal) <sup>2</sup>
Aging rate	$\pm 1$ ppm/yr for 20 years (spec), will not exceed $\pm 3.5$ ppm

#### Frequency readout accuracy (start, stop, center, marker)

$\pm$ (readout frequency x frequency reference accuracy + RBW centering + 0.5 x horizontal resolution)	Horizontal resolution = frequency span / (trace points – 1) RBW centering: <ul style="list-style-type: none"> <li>• 5% x RBW, FFT mode (nominal)</li> <li>• 16% x RBW, step mode (nominal)</li> </ul>
--	--

#### Marker frequency counter

Accuracy	$\pm$ (marker frequency x frequency reference accuracy + counter resolution)
Resolution	0.1, 1, 10 Hz

<sup>1</sup> The spectrum analyzer is tunable to 0 Hz or DC.

<sup>2</sup> The maximum drift expected in the frequency reference applicable when the ambient temperature changes  $\pm 5^\circ\text{C}$  from the temperature when the GPS signal was last connected.



## Spectrum Analyzer (Option 233 on Combination Analyzers) (continued)

### Frequency and time specifications (continued)

Frequency span	Spec	
Range	0 Hz (zero span), 10 Hz to maximum frequency range of instrument	
Resolution	1 Hz	
Accuracy	$\pm$ (2 x RBW centering + horizontal resolution) for detector = Normal	
Sweep time readout	Measured value of the time required to complete a sweep from start to finish, including time to tune receiver, acquire data, and process trace.	
Trace update	N991xB, N993xB, N995xB, N996xB (Nominal)	
Span = 20 MHz, RBW, VBW = 3 kHz	9 updates per second	
Span = 100 MHz, RBW, VBW autocoupled	25 updates per second	
Center frequency tune and transfer <sup>1</sup>	N991xB, N993xB (Nominal)	N995xB, N996xB (Nominal)
101 points, zero span	58 ms	83 ms
101 points, 1 MHz span	52 ms	78 ms
101 points, 100 MHz span	56 ms	84 ms
Sweep time, zero span	N991xB, N993xB, N995xB, N996xB (Nominal)	
Range	1 $\mu$ s to 6000 s	
Resolution	100 ns	
Readout	Entered value representing trace horizontal scale range	
Trigger (for zero span and FFT sweeps)		
Trigger type	Free run, external, video, RF burst, periodic	
Trigger slope	Positive edge, negative edge	
Trigger delay	Range: -150 ms to 10 s Resolution: 100 ns	
Auto trigger	Forces a periodic acquisition in the absence of a trigger event Range: 0 (off) to 30 s	
Trigger position (zero span)	Controls horizontal position of the pulse edge; use sweep time to zoom into pulse edge Range: 0 to 10, integer steps; 0 is left edge of graticule, 10 is right edge of graticule	
RF burst trigger	Nominal	
Dynamic range	40 dB	
Bandwidth	20 MHz	
Operating frequency range	20 MHz to maximum instrument frequency	
Sweep (trace) point range		
All spans	101, 201, 401, 601, 801, 1001 (defaults to 401) Arbitrary 2 to 20,001 settable through soft key "# Points" or SCPI	

<sup>1</sup> Within full frequency range of instrument, not band dependent

## Spectrum Analyzer (Option 233 on Combination Analyzers) (continued)

### Frequency and time specifications (continued)

Resolution bandwidth (RBW)	Nominal	
Range (-3 dB bandwidth)		
Zero span	10 Hz to 5 MHz	1, 3, 10 sequence
Non-zero span	1 Hz to 5 MHz	1, 1.5, 2, 3, 5, 7.5, 10 sequence < 300 kHz, 300 kHz, 1 MHz, 3 MHz, 5 MHz (Other RBWs may be set depending on settings)
		Step keys change RBW in 1, 3, 10 sequence
Selectivity (-60 dB / -3 dB)	4:1	
Bandwidth accuracy	Nominal	
Zero span	10 Hz to 1 MHz	± 5%
	3 MHz	± 10%
	5 MHz	± 15%
Non-zero span	1 Hz to 100 kHz	± 1%
	300 kHz to 1 MHz	± 5%
	3 MHz	± 10%
	5 MHz	± 15%
Video bandwidth (VBW)	1 Hz to 5 MHz	
		1, 1.5, 2, 3, 5, 7.5, 10 sequence

### Amplitude accuracy and range specifications

Amplitude range		
Measurement range	DANL to +20 dBm	
Input attenuator range	0 to 40 dB, in 5 dB steps	
Preamp	Nominal	
Frequency range	Full band (9 kHz to maximum frequency of instrument)	
Gain	N991xB, N993xB	+20 dB, 9 kHz to 26.5 GHz
	N995xB, N996xB	+15 dB, 9 kHz to 54 GHz
Max safe input level	Average CW power	DC
N991xB, N993xB	+27 dBm, 0.5 watts	± 50 VDC
N995xB, N996xB	+25 dBm, 0.3 watts	± 40 VDC
Display range		
Log scale	10 divisions	
	0.01 to 100 dB/division in 0.01 dB steps	
Linear scale	10 divisions	
Scale units	dBm, dBmV, dBμV, dBmA, dBμA, W, V, A, dBμV/m, dBμA/m, dBG, dBT	

## Spectrum Analyzer (continued)

### Amplitude accuracy and range specifications (continued)

<b>50 MHz absolute amplitude accuracy (dB)</b>			
10 dB attenuation, input signal -40 to -5 dBm, peak detector, preamplifier off <sup>1</sup> , 300 Hz RBW, all settings auto-coupled. No warm-up required.			
		Spec (-10 to 55 °C)	Typical (-10 to 55 °C)
<b>N991xB, N993xB, N995xB, N996xB</b>		± 0.60	± 0.20
<b>Total absolute amplitude accuracy (dB)</b>			
10 dB attenuation, input signal -15 to -5 dBm, peak detector, preamplifier off <sup>2</sup> , 300 Hz RBW, all settings auto-coupled, includes frequency response uncertainties. No warm-up required.			
		Spec (-10 to 55 °C)	Typical (-10 to 55 °C)
<b>N991xB, N993xB<sup>3</sup></b>	9 kHz to 100 kHz <sup>4</sup>	± 2.00	± 0.25
	> 100 kHz to 500 MHz <sup>4,5</sup>	± 0.80	± 0.20
	> 500 MHz to 16.3 GHz <sup>5</sup>	± 1.00	± 0.20
	> 16.3 to 18 GHz <sup>5</sup>	± 1.00	± 0.30
	> 18 to 26.5 GHz <sup>6</sup>	± 1.10	± 0.35
<b>N995xB, N996xB<sup>7</sup></b>	9 kHz to 500 kHz <sup>8</sup>	± 2.50	± 0.79
	≥ 500 kHz to 15 MHz <sup>9</sup>	± 1.10	± 0.38
	≥ 15 MHz to 18 GHz <sup>10</sup>	± 1.10	± 0.18
	≥ 18 to 26.5 GHz <sup>11</sup>	± 1.20	± 0.21
	≥ 26.5 to 32 GHz <sup>12</sup>	± 1.50	± 0.30
	≥ 32 to 36 GHz <sup>13</sup>	± 1.90	± 0.33
	≥ 36 to 44 GHz <sup>14</sup>	± 1.90	± 0.34
	≥ 44 to 50 GHz <sup>15</sup>	± 1.90	± 0.35
≥ 50 to 54 GHz <sup>16</sup>	± 3.50	± 0.73	
Resolution bandwidth switching uncertainty	Nominal		
RBW < 5 MHz	0.0 dB		
For signals not at center frequency	0.7 dB peak-to-peak		

<sup>1</sup> The spec and typical values, with preamp on, are identical to that with preamp off, but the input signal levels are -40 to -20 dBm

<sup>2</sup> The N991xB and N993xB preamp on specification uses 20 dB attenuation, input signal -25 to -15 dBm. The N995xB and N996xB preamp on specification uses 20 dB attenuation with -20 dBm input.

<sup>3</sup> Preamplifier on specification uses 20 dB attenuation, input signal -20 dBm. All the total absolute amplitude accuracy values listed apply with preamplifier on except for the spec value at 9 to 500 kHz which is ±4 dB.

<sup>4</sup> For frequencies 9 to 300 kHz, total absolute amplitude accuracy (Typical value) is ±0.8 dB with preamplifier on.

<sup>5</sup> For frequencies > 300 kHz to 18 GHz, total absolute amplitude accuracy (Spec and Typical values) apply with preamplifier off or on.

<sup>6</sup> For frequencies > 18 to 26.5 GHz, total absolute amplitude accuracy (Spec value) is ± 1.20 dB with preamplifier on.

<sup>7</sup> Preamplifier on specification and typical are identical to that with preamplifier off, unless noted otherwise.

<sup>8</sup> For frequencies 9 to 500 kHz, total absolute amplitude accuracy spec and typical with preamplifier on are ±4 dB and ±0.9 dB, respectively.

<sup>9</sup> For frequencies 500 kHz to 15 MHz, total absolute amplitude accuracy typical with preamplifier on is ±0.25 dB,

<sup>10</sup> For frequencies 15 MHz to 18 GHz, total absolute amplitude accuracy typical with preamplifier on is ±0.23 dB,

<sup>11</sup> For frequencies 18 to 26.5 GHz, total absolute amplitude accuracy typical with preamplifier on is ±0.27 dB.

<sup>12</sup> For frequencies 26.5 to 32 GHz, total absolute amplitude accuracy typical with preamplifier on is ±0.36 dB.

<sup>13</sup> For frequencies 32 to 36 GHz, total absolute amplitude accuracy typical with preamplifier on is ±0.36 dB.

<sup>14</sup> For frequencies 36 to 44 GHz, total absolute amplitude accuracy typical with preamplifier on is ±0.38 dB.

<sup>15</sup> For frequencies 44 to 50 GHz, total absolute amplitude accuracy typical with preamplifier on is ±0.41 dB.

<sup>16</sup> For frequencies 50 to 54 GHz, total absolute amplitude accuracy typical with preamplifier on is ±0.77 dB.

## Spectrum Analyzer (continued)

### Amplitude accuracy and range specifications (continued)

RF input VSWR		Nominal
N991xB, N993xB (0 dB attenuation)	10 MHz to 2.7 GHz	1.7 : 1
	> 2.7 to 7.5 GHz	1.5 : 1
	> 7.5 to 26.5 GHz	2.0 : 1
N995xB, N996xB (0 dB attenuation)	10 MHz to 2.7 GHz	1.7 : 1
	> 2.7 to 7.5 GHz	1.6 : 1
	> 7.5 to 26.5 GHz	2.0 : 1
	> 26.5 to 40 GHz	2.1 : 1
	> 40 to 50 GHz	2.7 : 1
	> 50 to 54 GHz	2.3 : 1
<b>Reference level</b>		
Range	-210 to +90 dBm	
<b>Traces</b>		
Detectors	Normal, positive peak, negative peak, sample, average (RMS)	
States	Clear/write, max hold, min hold, average, view, blank	
	Number of averages: 1 to 10,001	
Number	4: all four can be active simultaneously and in different states	
<b>Markers</b>		
Number of markers	6	
Type	Normal, delta, marker table	
Marker functions	Noise, band power, frequency counter	
Audio beep	Volume and tone change with signal strength	
Marker table	Display 6 markers	
Mkr →	Peak, next peak, peak left, peak right, center frequency, reference level, minimum	
	Tune frequency, for AM/FM tune and listen	
Marker properties	Peak criteria: peak excursion, peak threshold	
	Delta reference fixed: Off or On	
	Time zero fixed: Off or On	

## Spectrum Analyzer (continued)

### Dynamic range specifications

#### Displayed average noise level (DANL) - (dBm)

Input terminated, RMS detection, log averaging, 0 dB input attenuation, reference level of -20 dBm, normalized to 1 Hz RBW, measured at non-zero frequency span

N991xB, N993xB	Preamp off		Preamp on	
	Spec (-10 to 55 °C)	Typical (-10 to 55 °C)	Spec (-10 to 55 °C)	Typical (-10 to 55 °C)
9 kHz to 2 MHz	-122	-134	-129	-148
≥ 2 MHz to 2.1 GHz	-137	-147	-156	-163
≥ 2.1 to 2.6 GHz	-136	-143	-155	-160
≥ 2.6 to 4.5 GHz	-141	-147	-156	-162
≥ 4.5 to 7.5 GHz	-134	-144	-152	-160
≥ 7.5 to 13 GHz	-138	-143	-156	-161
≥ 13 to 18 GHz	-134	-139	-153	-158
≥ 18 to 22 GHz	-132	-138	-152	-157
≥ 22 to 25 GHz	-128	-136	-149	-155
≥ 25 to 26.5 GHz	-126	-132	-146	-152
N995xB, N996xB	Preamp off		Preamp on	
	Spec (-10 to 55 °C)	Typical (-10 to 55 °C)	Spec (-10 to 55 °C)	Typical (-10 to 55 °C)
9 kHz to 2 MHz	-94	-129	-98	-143
≥ 2 MHz to 2.1 GHz	-137	-148	-155	-163
≥ 2.1 to 7.5 GHz	-138	-148	-155	-161
≥ 7.5 to 13 GHz	-141	-147	-155	-161
≥ 13 to 26.5 GHz	-132	-142	-145	-155
≥ 26.5 to 32 GHz	-143	-150	-154	-160
≥ 32 to 40 GHz	-133	-144	-147	-156
≥ 40 to 44 GHz	-129	-138	-142	-151
≥ 44 to 50 GHz	-118	-133	-131	-144
≥ 50 to 54 GHz	-113	-126	-126	-139

## Spectrum Analyzer (continued)

### Dynamic range specifications (continued)

Residual responses (dBm)		Nominal
Input terminated preamp off, 0 dB attenuation		
N991xB, N993xB	9 kHz to 10 MHz <sup>1</sup>	-90
	≥ 10 MHz to 10 GHz	-105
	≥ 10 GHz to 15 GHz	-100
	≥ 15 GHz to 26.5 GHz	-115
N995xB, N996xB	9 kHz to 9 MHz	-90
	≥ 9 MHz to 54 GHz	-110

Input related responses (dBc)			Nominal
N991xB, N993xB			
Tuned frequency (f)	Excitation frequency	Spur frequency	
-30 dBm signal at mixer input (excludes frequencies listed below)			-80
f > 2.6 GHz to 4 GHz	f + 9.93375 GHz / 2	f	-65
f > 6 GHz to 7.5 GHz	f + 2 * 9.93375 GHz	f	-65
f > 12 GHz to 14 GHz	f + 2 * 3.56625 GHz	f	-70
f > 19.5 GHz to 23 GHz	f - 2 * 3.56625 GHz	f	-75
f > 23 GHz to 26.5 GHz	f - 2 * 3.56625 GHz	f	-55
f < 7.5 GHz	f + 933.75 MHz / 2	f	-80
f > 4 GHz to 12 GHz	f +/- 2 * 933.75 MHz	f	-65
fOffset = frequency offset of excitation frequency from tuned frequency (f)			
f < 2.6 GHz, f > 7.5 GHz to 19.5 GHz	f + fOffset	f - n * fOffset, (n = 1, 2, 3, ...)	-75
	f + fOffset	f - 2 * (5.625 MHz +/- fOffset)	-70
f > 2.6 GHz to 7.5 GHz, f > 19.5 GHz	f + fOffset	f - n * fOffset, (n = 1, 2, 3, ...)	-75
	f + fOffset	f + 2 * (5.625 MHz +/- fOffset)	-70

<sup>1</sup> Excludes 5.625 MHz at -85 dBm.

Input related responses (dBc)			Nominal
N995xB, N996xB			
Tuned frequency (f)	Excitation frequency	Spur frequency	
-30 dBm signal at mixer input (excludes frequencies listed below)			-85
$f \geq 12.3$ to 15.7 GHz	$f + 2 * 3.56625$ GHz	f	-75
$f \geq 19.5$ to 26.5 GHz	$f - 2 * 3.56625$ GHz	f	-55
$f \geq 26.5$ to 32.5 GHz	$f + 2 * 3.56625$ GHz	f	-70
$f \geq 32.5$ to 39.5 GHz	$f - 2 * 3.56625$ GHz	f	-55
$f \geq 39.5$ to 43 GHz	$f - 2 * 3.56625$ GHz	f	-50
$f \geq 43$ to 46.2 GHz	$f + 2 * 3.56625$ GHz	f	-45
$f \geq 46.2$ to 50 GHz	$f - 2 * 3.56625$ GHz	f	-45
$f \geq 50$ to 54 GHz	$f - 2 * 3.56625$ GHz	f	-45
$f < 2.6$ GHz	$f + 3.56625$ GHz / 2	f	-90
$f \geq 2.6$ to 9.5 GHz	$f + 9.93375$ GHz / 2	f	-75
$f \geq 9.5$ to 15.7 GHz	$f + 3.56625$ GHz / 2	f	-80
$f \geq 15.7$ to 19.5 GHz	$f + 3.56625$ GHz / 2	f	-85
$f \geq 19.5$ to 26.5 GHz	$f - 3.56625$ GHz / 2	f	-85
$f \geq 26.5$ to 29 GHz	$f + 3.56625$ GHz / 2	f	-60
$f \geq 29$ to 32.5 GHz	$f + 3.56625$ GHz / 2	f	-65
$f \geq 32.5$ to 39.5 GHz	$f - 3.56625$ GHz / 2	f	-60
$f \geq 39.5$ to 43 GHz	$f - 3.56625$ GHz / 2	f	-70
$f \geq 43$ to 46.2 GHz	$f + 3.56625$ GHz / 2	f	-75
$f \geq 46.2$ to 50 GHz	$f - 3.56625$ GHz / 2	f	-75
$f \geq 50$ to 54 GHz	$f - 3.56625$ GHz / 2	f	-80
fOffset = frequency offset of excitation frequency from tuned frequency (f)			
$f < 2.6$ GHz, $f > 7.5$ GHz to 19.5 GHz, $f > 26.5$ GHz to 32.5 GHz, $f > 43$ GHz to 46.2 GHz	$f + f\text{Offset}$	$f - n * f\text{Offset}$ , (n = 1, 2, 3, ...)	-75
	$f + f\text{Offset}$	$f - 2 * (5.625 \text{ MHz} \pm f\text{Offset})$	-70
$f > 2.6$ GHz to 7.5 GHz, $f > 19.5$ GHz to 26.5 GHz, $f > 32.5$ GHz to 43 GHz, $f > 46.2$ GHz	$f + f\text{Offset}$	$f - n * f\text{Offset}$ , (n = 1, 2, 3, ...)	-75
	$f + f\text{Offset}$	$f + 2 * (5.625 \text{ MHz} \pm f\text{Offset})$	-70



## Spectrum Analyzer (continued)

### Dynamic range specifications (continued)

Other spurious responses (dBc)		
Nominal	N991xB, N993xB	N995xB, N996xB
LO related spurs		
9 kHz to 13 GHz	-75	-75
≥13 to 26.5 GHz	-70	-70
≥ 26.5 to 54 GHz	-	-64
Sideband	-80	-80
Battery charging sideband <sup>1</sup>	-70	-70
Second harmonic distortion		Nominal
-30 dBm signal at mixer input	SHI (dBm)	Distortion (dBc)
<b>N991xB, N993xB</b>		
10 to 50 MHz	+35	-65
> 50 MHz to 1.3 GHz	+50	-80
≥ 1.3 to 3.75 GHz	+35	-65
≥ 3.75 to 13.25 GHz	+50	-80
<b>N995xB, N996xB</b>		
10 to 100 MHz	+35	-65
> 100 MHz to 1.3 GHz	+50	-80
≥ 1.3 to 3.75 GHz	+35	-65
≥ 3.75 to 20 GHz	+25	-55
≥ 20 to 25 GHz	+20	-50
≥ 25 to 27 GHz	+15	-45

<sup>1</sup> Charging sidebands will only occur when battery is being charged. The charging sidebands will have an offset between 50 kHz and 350 kHz and they may have harmonics.

<b>Third order intermodulation distortion (TOI) – (dBm)</b>		
Two -15 dBm signals, 100 kHz spacing at mixer input (-10 to 55 °C)		<b>Typical</b>
<b>N991xB, N993xB</b>	50 MHz to 500 MHz	+8.5
	≥ 500 MHz to 2 GHz	+11
	≥ 2 to 2.4 GHz	+13
	≥ 2.4 to 2.5 GHz	+13.5
	≥ 2.5 to 7.5 GHz	+9.5
	≥ 7.5 to 10 GHz	+11
	≥ 10 to 20 GHz	+13
	≥ 20 to 26.5 GHz	+15
Two -15 dBm signals, 100 kHz spacing, Ref. level = -10 dBm		<b>Nominal</b>
<b>N995xB, N996xB</b>	50 MHz to 500 MHz	+13
	≥ 500 MHz to 1.4 GHz	+11.5
	≥ 1.4 to 2.4 GHz	+15.5
	≥ 2.4 to 2.42 GHz	+16
	≥ 2.42 to 2.6 GHz	+17
	≥ 2.6 to 7.5 GHz	+13
	≥ 7.5 to 9.5 GHz	+10.5
	≥ 9.5 to 16.3 GHz	+11.5
	≥ 16.3 to 19.5 GHz	+13.5
	≥ 19.5 to 23 GHz	+14.5
	≥ 23 to 26.5 GHz (all >23 GHz tested with 2 MHz spacing)	+16.5
	≥ 26.5 to 32 GHz	+11
	≥ 32 to 36 GHz	+11.5
	≥ 36 to 39.5 GHz	+12
	≥ 39.5 to 43 GHz	+17.5
	≥ 43 to 46.2 GHz	+22
≥ 46.2 to 50 GHz	+22	
≥ 50 to 54 GHz	+21	
<b>Spur free dynamic range (dB) at 2.4 GHz 2/3 (TOI – DANL)</b>		<b>Nominal</b>
<b>N991xB, N993xB, N995xB, N996xB</b>		>104

## Spectrum Analyzer (continued)

### Distortion and noise limited (10 Hz RBW) dynamic range (nominal)

Applies to N991xB and N993xB

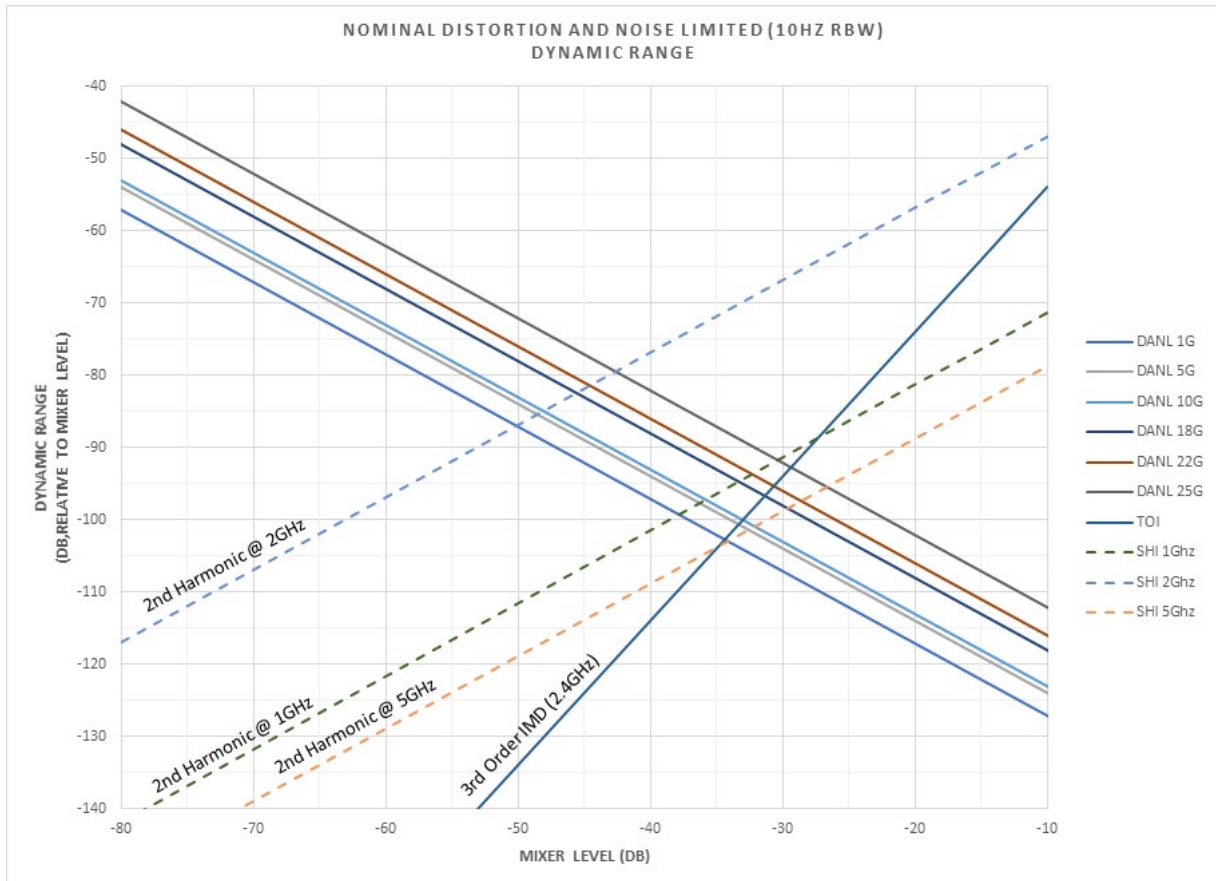

## Spectrum Analyzer (continued)

Distortion and noise limited (10 Hz RBW) dynamic range (nominal)

Applies to N995xB and N996xB

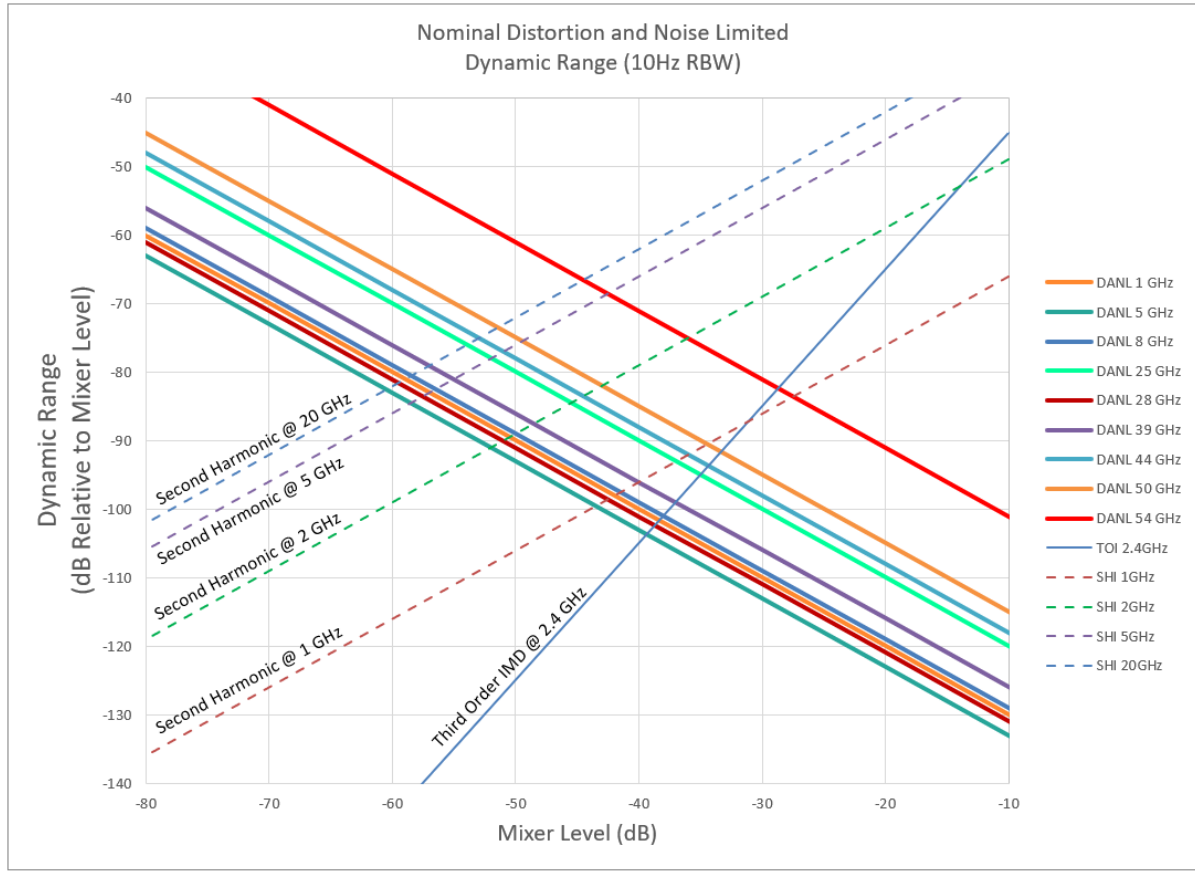

## Spectrum Analyzer (continued)

### SSB phase noise at 1 GHz center frequency

Phase noise (dBc/Hz)				
SSB phase noise at 1 GHz				
Offset	N991xB, N993xB		N995xB, N996xB	
	Spec (-10 to 55 °C)	Typical (-10 to 55 °C)	Spec (-10 to 55 °C)	Typical (-10 to 55 °C)
10 kHz	-111	-117	-109	-113
30 kHz	-110	-115	-110	-114
100 kHz	-105	-111	-105	-111
1 MHz	-119	-124	-119	-124
3 MHz <sup>1</sup>	-123	-128	-125	-130
5 MHz	-124	-129	-126	-130

### Phase noise at different center frequencies (nominal)

Applies to N991xB and N993xB

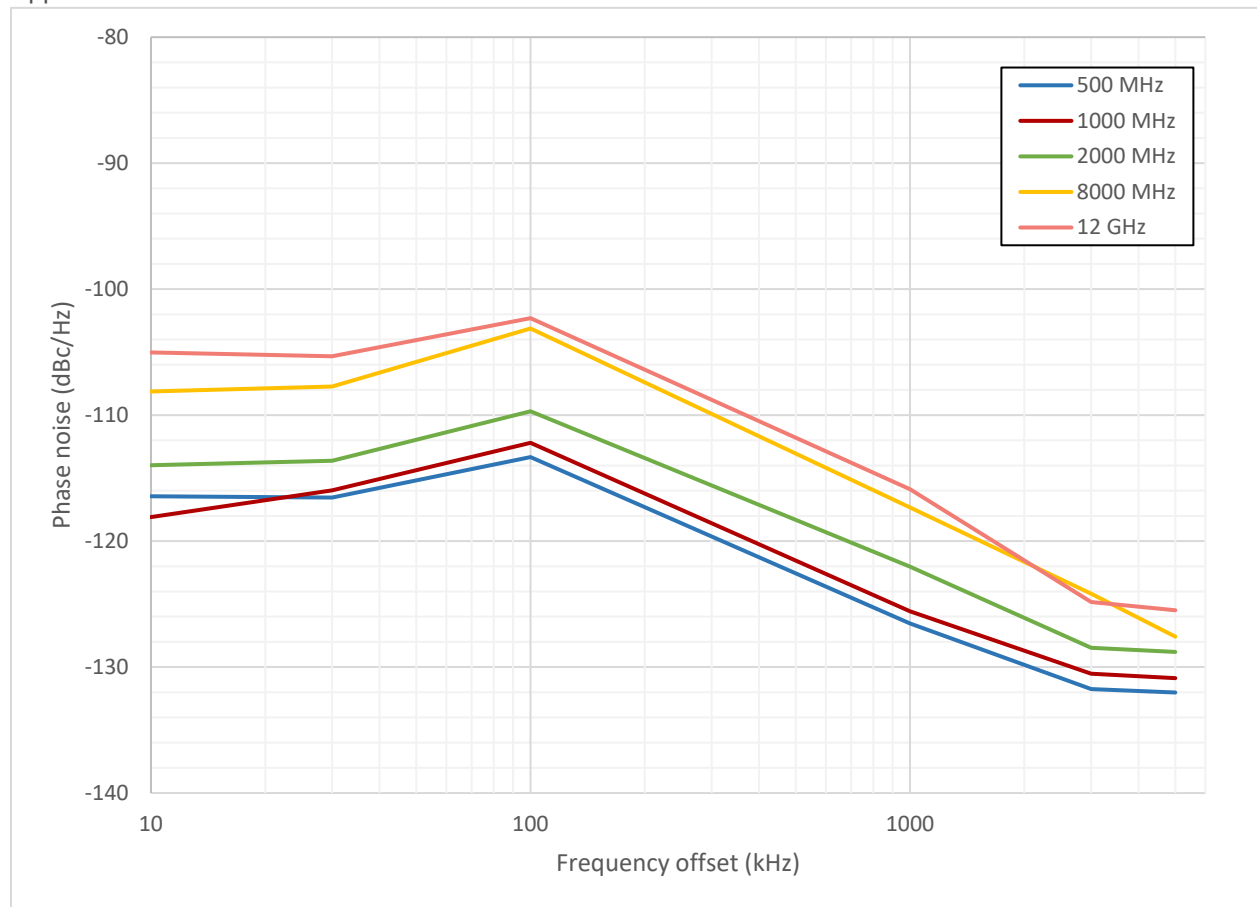

<sup>1</sup> Tested at 2.99 MHz

## Spectrum Analyzer (continued)

### Phase noise at different center frequencies (nominal)

Applies to N995xB and N996xB

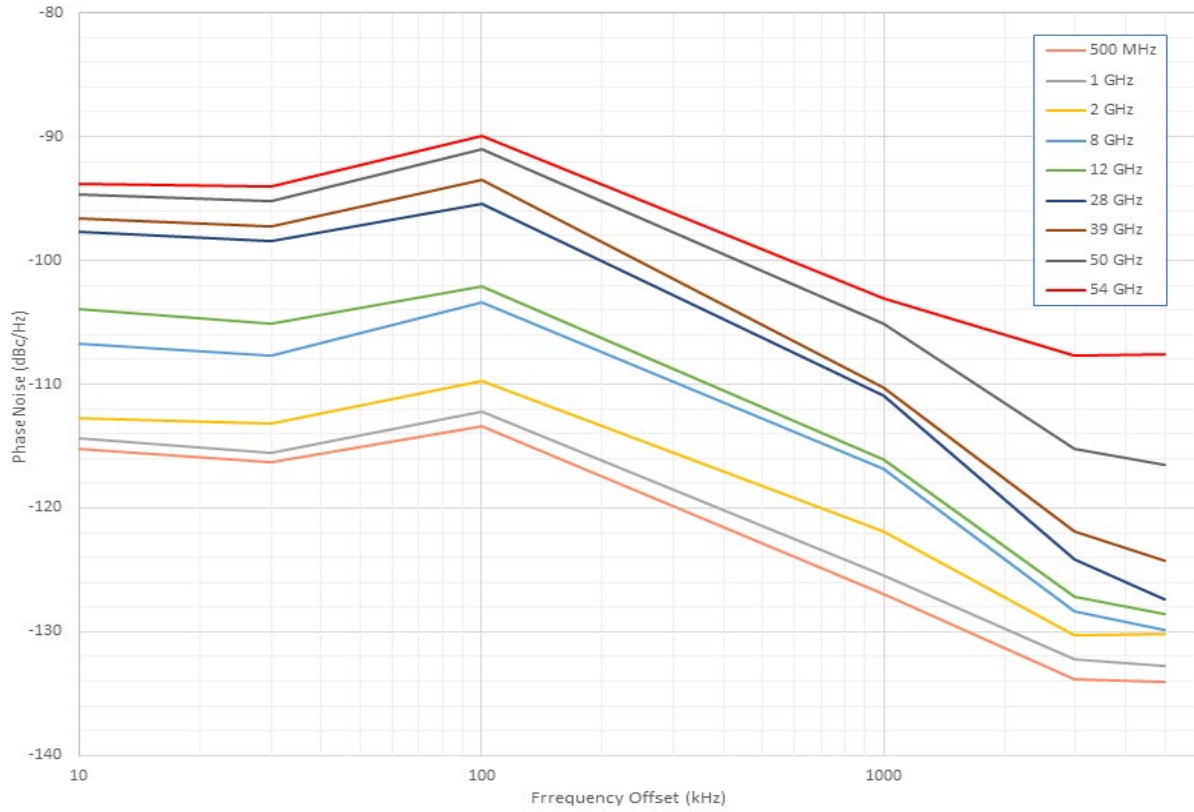

## Spectrum Analyzer (continued)

### Dynamic range versus offset frequency versus RBW (nominal)<sup>1</sup>

Applies to N991xB, N993xB, N995xB, and N996xB

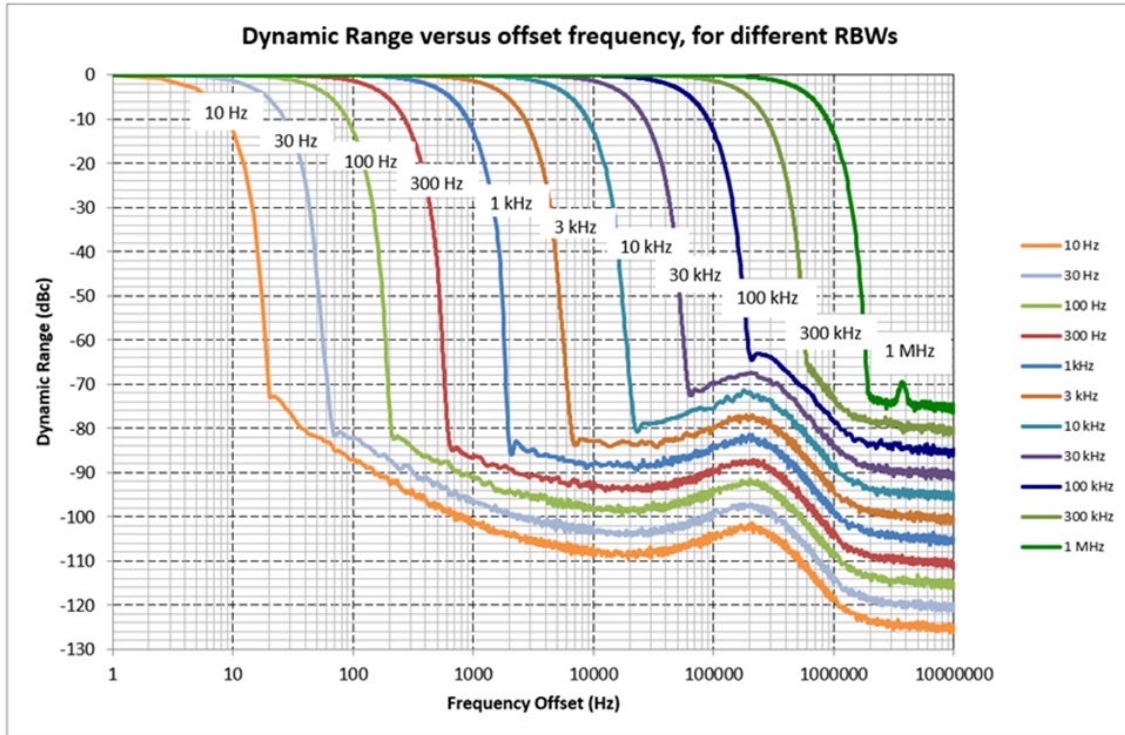

<sup>1</sup> For 1 MHz RBW, the sideband observed may degrade the dynamic range to -70 dBc



## Tracking Generator or Independent Source

The performance listed in this section applies to the tracking generator and independent source capabilities available in the following models:

FieldFox RF & microwave (combination) analyzers:	N9913B, N9914B, N9915B, N9916B, N9917B, N9918B
FieldFox RF & microwave signal analyzers:	N9933B, N9934B, N9935B, N9936B, N9937B, N9938B
FieldFox microwave (combination) analyzers:	N9950B, N9951B, N9952B, N9953B
FieldFox microwave signal analyzers:	N9960B, N9961B, N9962B, N9963B

See [FieldFox Configuration Guide](#) for option information. Many capabilities listed in this Data Sheet require options.

Note: Traditional tracking generators track the receiver frequency only. In FieldFox analyzers, the tracking generator frequency can be set to either track the receiver frequency, or act as an independent CW source.

	Models	Tracking generator or independent source frequency range
<b>N991xB, N993xB</b>	N9913B, N9933B	30 kHz to 4 GHz
	N9914B, N9934B	30 kHz to 6.5 GHz
	N9915B, N9935B	30 kHz to 9 GHz
	N9916B, N9936B	30 kHz to 14 GHz
	N9917B, N9937B	30 kHz to 18 GHz
	N9918B, N9938B	30 kHz to 26.5 GHz
<b>N995xB, N996xB</b>	N9950B, N9960B	300 kHz to 32 GHz
	N9951B, N9961B	300 kHz to 44 GHz
	N9952B, N9962B	300 kHz to 50 GHz
	N9953B, N9963B	300 kHz to 54 GHz
<b>Power step size</b>		
	Power settable in 1 dB steps across power range	
<b>Functions</b>		
Mode	Continuous wave (CW), CW coupled, tracking (swept frequency)	
Operations	Normalization, frequency offset, spectral reversal	

## Tracking Generator or Independent Source (continued)

Output power (high) (dBm)	Frequency	Typical
<b>N991xB, N993xB</b>	30 kHz to 500 kHz	-4
	> 500 kHz to 10 MHz	0
	> 10 MHz to 1 GHz	9
	> 1 to 5 GHz	8
	> 5 to 10 GHz	7
	> 10 to 18 GHz	6
	> 18 to 26.5 GHz	3
<b>N995xB, N996xB</b>	300 kHz to 1 MHz	-5
	> 1 to 10 MHz	-1
	> 10 MHz to 6 GHz	5
	> 6 to 18 GHz	6
	> 18 to 26.5 GHz	4
	> 26.5 to 32 GHz	2
	> 32 to 40 GHz	2
	> 40 to 44 GHz	-3
	> 44 to 50 GHz	-4
	> 50 to 54 GHz	-8
<b>Power level accuracy<sup>1</sup></b>	<b>Nominal</b>	
<b>N991xB, N993xB</b>	<b>Port 1 at -15 dBm</b>	
> 500 kHz to 10 MHz	± 1 dB	
> 10 MHz to 26.5 GHz	± 0.5 dB	
<b>N995xB, N996xB<sup>2</sup></b>	<b>Port 1 at -15 dBm</b>	
300 kHz to 54 GHz	± 0.5 dB	

<sup>1</sup> N991xB power levels are calibrated based on PNA-X's tuned receiver, which means primarily the fundamental is included (for frequencies  $\geq 10$  MHz). For frequencies  $< 10$  MHz, power levels are calibrated in the factory using a broadband power sensor.

<sup>2</sup> N995xB power levels are calibrated based on PNA-X's tuned receiver for the entire frequency range.

Dynamic range (dB)	Frequency	Typical (-10 to 55 °C) Preamp off	Nominal Preamp on
<b>N991xB, N993xB</b>	300 kHz to 2 MHz	84	100
	> 2 MHz to 2.6 GHz	99	112
	> 2.6 to 7 GHz	98	112
	> 7 to 7.5 GHz	94	112
	> 7.5 to 11 GHz	96	112
	> 11 to 16 GHz	81	95
	> 16 to 18 GHz	86	95
	> 18 to 21 GHz	90	95
	> 21 to 23 GHz	88	95
	> 23 to 25 GHz	78	90
	> 25 to 26.5 GHz	79	90
<b>N995xB, N996xB</b>	500 kHz to 2 MHz	84	99
	> 2 to 100 MHz	90	106
	> 100 MHz to 17.5 GHz	97	114
	> 17.5 to 21 GHz	86	102
	> 21 to 23.8 GHz	83	99
	> 23.8 to 26.6 GHz	73	91
	> 26.6 to 37.5 GHz	96	107
	> 37.5 to 41.5 GHz	90	103
	> 41.5 to 46 GHz	84	99
	> 46 to 50 GHz	80	97
	> 50 to 54 GHz	73	90

## Real-Time Spectrum Analyzer (RTSA) (Option 350)

The performance listed in this section applies to the real-time spectrum analyzer capabilities available in the following models:

FieldFox RF & microwave (combination) analyzers:	N9913B, N9914B, N9915B, N9916B, N9917B, N9918B
FieldFox RF & microwave signal analyzers:	N9933B, N9934B, N9935B, N9936B, N9937B, N9938B
FieldFox microwave (combination) analyzers:	N9950B, N9951B, N9952B, N9953B
FieldFox microwave signal analyzers:	N9960B, N9961B, N9962B, N9963B

See [FieldFox Configuration Guide](#) for option information. Many capabilities listed in this Data Sheet require options.

	Models	Real-time analysis frequency range <sup>1</sup>	
<b>N991xB, N993xB</b>	N9913B, N9933B	9 kHz to 4 GHz	Usable to 5 kHz
	N9914B, N9934B	9 kHz to 6.5 GHz	Usable to 5 kHz
	N9915B, N9935B	9 kHz to 9 GHz	Usable to 5 kHz
	N9916B, N9936B	9 kHz to 14 GHz	Usable to 5 kHz
	N9917B, N9937B	9 kHz to 18 GHz	Usable to 5 kHz
	N9918B, N9938B	9 kHz to 26.5 GHz	Usable to 5 kHz
<b>N995xB, N996xB</b>	N9950B, N9960B	9 kHz to 32 GHz	Usable to 5 kHz
	N9951B, N9961B	9 kHz to 44 GHz	Usable to 5 kHz
	N9952B, N9962B	9 kHz to 50 GHz	Usable to 5 kHz
	N9953B, N9963B	9 kHz to 54 GHz	Usable to 5 kHz

Real-time analysis			
Measurements	Density Spectrum, Spectrogram, Real-time Spectrum		
Maximum real-time bandwidth	10 MHz (Standard)	40 MHz (Opt B04)	100/120 MHz (Opt B10)
Resolution bandwidth (Span dependent, $20 \leq \text{Span}/\text{RBW} \leq 280$ )	1 Hz to 500 kHz	1 Hz to 2 MHz	1 Hz to 5 MHz
Minimum signal duration with 100% probability of intercept (POI) at full amplitude accuracy	9.13 us	6.13 us	5.52 us
Minimum detectable signal <sup>2</sup>	11 ns	11 ns	47 ns
Min. acquisition time (Density Spectrum)	20 ms	20 ms	20 ms
Min. acquisition time (Spectrogram)	500 us/div	500 us/div	500 us/div
Max. acquisition time (Density Spectrum)	540 ms	337 ms	336 ms
Max. acquisition time (Spectrogram)	10 s/div	10 s/div	10 s/div
Spurious-free dynamic range	69 dB	65 dB	63/62 dB
IF flatness (for carrier frequency $\geq 1$ MHz)	0.1 dB (typical)	0.1 dB (typical)	0.1 dB (typical)
FFT rate	190,000 FFT/s		
Number of display points	821		
Traces			
Number of traces	4: all four can be active simultaneously and in different states		
Detectors	Normal, positive peak, negative peak, sample, average (RMS)		
States	Clear/write, max. hold, min. hold, average, view, blank		

<sup>1</sup> Performance specified above 1 MHz. Usable down to 5 kHz.

<sup>2</sup> Minimum detectable pulse width is the shortest pulse width of a pulsed CW signal that will display a peak amplitude that is no worse than 60 dB below the peak amplitude of a CW signal of the same power level for a defined span and auto-coupled RBW.

## RTSA (continued)

Markers	
Number of markers	6
Type	Normal, delta, peak
Mkr →	Peak, next peak, center frequency, reference level
Trigger	
Trigger type	Free run, external, video, RF burst, periodic

## I/Q Analyzer (IQA) (Option 351)

The specifications in this section apply to the I/Q analyzer capabilities available in the following models:

FieldFox RF & microwave (combination) analyzers:	N9913B, N9914B, N9915B, N9916B, N9917B, N9918B
FieldFox RF & microwave signal analyzers:	N9933B, N9934B, N9935B, N9936B, N9937B, N9938B
FieldFox microwave (combination) analyzers:	N9950B, N9951B, N9952B, N9953B
FieldFox microwave signal analyzers:	N9960B, N9961B, N9962B, N9963B

See [FieldFox Configuration Guide](#) for option information. Many capabilities listed in this Data Sheet require options.

	Models	I/Q analysis frequency range <sup>1</sup>
<b>N991xB, N993xB</b>	N9913B, N9933B	9 kHz to 4 GHz
	N9914B, N9934B	9 kHz to 6.5 GHz
	N9915B, N9935B	9 kHz to 9 GHz
	N9916B, N9936B	9 kHz to 14 GHz
	N9917B, N9937B	9 kHz to 18 GHz
	N9918B, N9938B	9 kHz to 26.5 GHz
<b>N995xB, N996xB</b>	N9950B, N9960B	9 kHz to 32 GHz
	N9951B, N9961B	9 kHz to 44 GHz
	N9952B, N9962B	9 kHz to 50 GHz
	N9953B, N9963B	9 kHz to 54 GHz

### Measurements

Spectrum (frequency domain)	Magnitude spectrum
Waveform (time domain)	RF envelope
	I/Q waveform (Dual simultaneous top and bottom windows: I vs. time and Q vs. time)

### Display (multi-domain) user defined

Set up and display up to 4 simultaneous and multi-domain measurements with any combination of the following:

- Frequency domain: Magnitude spectrum
- Time domain: RF envelope, Q vs. I (polar plot), Phase vs. time, Unwrapped phase vs. time, I vs. time, Q vs. time
- Time summary table showing I/Q capture settings: I/Q capture time, waveform start/stop, Spectrum FFT time

### Measurement setup

I/Q capture parameters	Capture time, sample rate, sample period, capture samples
I/Q streaming (Requires option 353)	Provides continuous streaming of IQ data up to 1.25 MSamples/sec (or maximum BW of 1 MHz) over the Ethernet port in either VITA49A or Decodio formats

<sup>1</sup> Performance specified above 1 MHz. Usable down to 5 kHz.

Bandwidth options	10 MHz (Standard)	40 MHz (Opt B04)	120 MHz (Opt B10)
Frequency span	10 Hz to 10 MHz	10 Hz to 40 MHz	10 Hz to 120 MHz

## I/Q Analyzer (IQA) (Option 351) (continued)

Bandwidth options	10 MHz (Standard) Typical (-10 to 55 °C)	40 MHz (Opt B04) Typical (-10 to 55 °C)	100/120 MHz (Opt B10) Typical (-10 to 55 °C)
<b>N991xB, N993xB</b>			
IF flatness			
Magnitude	± 0.07 dB	± 0.06 dB	± 0.11 dB/±0.13 dB
Phase deviation from linearity <sup>1</sup>	0.43° peak-to-peak 0.15° rms	1.4° peak-to-peak 0.6° rms	12.1° peak-to-peak 2°/5° rms
Group delay flatness (peak-to-peak) <sup>1</sup>	1.35 ns	0.9 ns	2.2 ns/3 ns
<b>N995xB, N996xB</b>			
IF flatness			
Magnitude	± 0.08 dB	± 0.11 dB	± 0.19 dB/± 0.21 dB
Phase deviation from linearity <sup>1</sup>	0.5° peak-to-peak 0.14° rms	1.52° peak-to-peak 0.69° rms	8.52°/11.32° peak-to-peak 3.88°/5.0° rms
Group delay flatness (peak-to-peak) <sup>1</sup>	1.6 ns	0.96 ns	2.84 ns/3.25 ns
<b>Bandwidth options</b>			
	<b>10 MHz (Standard)</b>	<b>40 MHz (Opt B04)</b>	<b>100/120 MHz (Opt B10)</b>
<b>N991xB, N993xB</b>	<b>Nominal</b>	<b>Nominal<sup>2</sup></b>	<b>Nominal<sup>3</sup></b>
EVM (at center frequency 1 GHz)			
5G NR 64 QAM	—	—	0.70%
LTE-A FDD TM3.1 (10 MHz)	0.50%	0.50%	0.50%
LTE-A FDD TM3.1 (20 MHz)	—	0.40%	0.40%
WCDMA TM4 (5 MHz)	0.70%	0.70%	0.70%
EVM (at center frequency 2.1 GHz)			
LTE-A FDD TM3.1 (10 MHz)	0.70%	0.70%	0.70%
LTE-A FDD TM3.1 (20 MHz)	—	0.50%	0.50%
WCDMA TM4 (5 MHz)	0.75%	0.75%	0.75%
EVM (at center frequency 3.5 GHz)			
5G NR 64 QAM	—	—	0.85%
LTE-A FDD TM3.1 (20 MHz)	—	0.80%	0.80%
EVM (at center frequency 5.8 GHz)			
5G NR 64 QAM	—	—	1%
EVM (at center frequency 24 GHz)			
5G NR 64 QAM	—	—	2%
<b>N995xB, N996xB</b>			
EVM (at center frequency 1 GHz)			
5G NR 64 QAM	—	—	0.70%
LTE-A FDD TM3.1 (10 MHz)	0.50%	0.50%	0.50%
LTE-A FDD TM3.1 (20 MHz)	—	0.60%	0.40%
WCDMA TM4 (5 MHz)	0.64%	0.70%	0.70%
EVM (at center frequency 2.1 GHz)			

<sup>1</sup> Not guaranteed below 50 MHz.

<sup>2</sup> Applies when fast channel equalization (default) is OFF.

<b>Bandwidth options</b>	<b>10 MHz (Standard)</b>	<b>40 MHz (Opt B04)</b>	<b>100/120 MHz (Opt B10)</b>
LTE-A FDD TM3.1 (10 MHz)	0.65%	0.65%	0.65%
LTE-A FDD TM3.1 (20 MHz)	—	0.60%	0.50%
WCDMA TM4 (5 MHz)	0.87%	0.75%	0.75%
<b>EVM (at center frequency 3.5 GHz)</b>			
5G NR 64 QAM	—	—	0.80%
LTE-A FDD TM3.1 (20 MHz)	—	0.80%	0.80%
<b>EVM (at center frequency 5.8 GHz)</b>			
5G NR 64 QAM	—	—	1%
<b>EVM (at center frequency 24 GHz)</b>			
5G NR 64 QAM	—	—	2.2%
<b>EVM (at center frequency 28 GHz)</b>			
5G NR 64 QAM	—	—	2.1%
<b>EVM (at center frequency 39 GHz)</b>			
5G NR 64 QAM	—	—	2.3%

<b>Data acquisition</b>	
Total capture memory	1024 MB
Length single I/Q capture	8 bytes/sample
Maximum length I/Q capture	128 MSa
Sample rate (I/Q pairs)	1.25 x span
ADC resolution	14 bits
<b>Maximum I/Q capture time</b>	
120 MHz span	0.89 s
100 MHz span	1 s
40 MHz span	2.6 s
10 MHz span	10.7 s
1 MHz span	107 s
100 kHz span	1073 s
10 kHz span	10737 s



## IQA (continued)

### Dynamic range specifications (wideband path)

<b>Displayed average noise level (DANL) - (dBm)</b>			
Input terminated, RMS detection, log averaging, 0 dB input attenuation, reference level of -20 dBm, normalized to 1 Hz RBW, measured at non-zero frequency span			
<b>N991xB, N993xB</b>	<b>Preamp OFF</b>	<b>Preamp ON</b>	
	<b>Typical (-10 to 55 °C)</b>	<b>Typical (-10 to 55 °C)</b>	
9 kHz to 2 MHz	-136	-151	
≥ 2 MHz to 120 MHz	-151	-165	
≥ 120 MHz to 2.6 GHz	-152	-165	
≥ 2.6 to 4.5 GHz	-153	-164	
≥ 4.5 to 6.5 GHz	-150	-163	
≥ 6.5 to 7.5 GHz	-148	-161	
≥ 7.5 to 9 GHz	-147	-163	
≥ 9 to 14 GHz	-146	-161	
≥ 14 to 16.3 GHz	-143	-159	
≥ 16.3 to 18 GHz	-141	-159	
≥ 18 to 23 GHz	-141	-158	
≥ 23 to 26.5 GHz	-137	-155	
<b>N995xB, N996xB</b>	<b>Preamp OFF</b>	<b>Preamp ON</b>	
	<b>Typical (-10 to 55 °C)</b>	<b>Typical (-10 to 55 °C)</b>	
9 kHz to 2 MHz	-130	-143	
≥ 2 MHz to 2.1 GHz	-153	-165	
≥ 2.1 to 7.5 GHz	-153	-163	
≥ 7.5 to 13 GHz	-151	-162	
≥ 13 to 26.5 GHz	-145	-157	
≥ 26.5 to 32 GHz	-155	-160	
≥ 32 to 40 GHz	-150	-157	
≥ 40 to 44 GHz	-143	-153	
≥ 44 to 50 GHz	-136	-147	
≥ 50 to 54 GHz	-130	-142	
<b>Input related responses (dBc)</b>			<b>Nominal</b>
<b>Tuned frequency (f)</b>	<b>Excitation frequency</b>	<b>Spur frequency</b>	<b>N991xB, N993xB</b>
-30 dBm signal at mixer input (excludes frequencies listed below)			-75
f = tuned frequency			
f > 2.6 GHz to 4 GHz	f + 10.125 GHz / 2	f	-65
f > 6 GHz to 7.5 GHz	f + 2 * 10.125 GHz	f	-65
f > 7.5 GHz to 16 GHz	f + 2 * 3.375 GHz	f	-70
f > 19.5 GHz to 23 GHz	f - 2 * 3.375 GHz	f	-75
f > 23 GHz to 26.5 GHz	f - 2 * 3.375 GHz	f	-50
f < 7.5 GHz	f + 1.125 GHz / 2	f	-75

Input related responses (dBc)			Nominal
f > 4 GHz to 12 GHz	f +/- 2 * 1.125 GHz	f	-80
fOffset = frequency offset of excitation frequency from tuned frequency (f)			
f < 2.6 GHz, f > 7.5 GHz to 19.5 GHz	f + fOffset	f - fOffset	-70
	f + fOffset	f - 2 * (37.5 MHz - fOffset)	-65
	f + fOffset	f + 2 * (112.5 MHz + fOffset)	-60
	f + fOffset, (fOffset < 0)	f - 6 * (37.5 MHz - fOffset)	-75
	f + fOffset, (fOffset > 0)	f - 6 * (12.5 MHz + fOffset)	-75
f > 2.6 GHz to 7.5 GHz, f > 19.5 GHz	f + fOffset	f - fOffset	-70
	f + fOffset	f + 2 * (37.5 MHz - fOffset)	-65
	f + fOffset	f - 2 * (112.5 MHz + fOffset)	-65
	f + fOffset, (fOffset > 0)	f + 6 * (37.5 MHz - fOffset)	-75
	f + fOffset, (fOffset < 0)	f + 6 * (12.5 MHz + fOffset)	-75

Input related responses (dBc)			Nominal
Tuned frequency (f)	Excitation frequency	Spur frequency	N995xB, N996xB
-30 dBm signal at mixer input (excludes frequencies listed below)			-80
f ≥ 12.3 to 15.7 GHz	f + 2 * 3.375 GHz	f	-80
f ≥ 15.7 to 19.5 GHz	f + 2 * 3.375 GHz	f	-70
f ≥ 19.5 to 26.5 GHz	f - 2 * 3.375 GHz	f	-50
f ≥ 26.5 to 29 GHz	f + 2 * 3.375 GHz	f	-70
f ≥ 29 to 32.5 GHz	f + 2 * 3.375 GHz	f	-55
f ≥ 32.5 to 36 GHz	f - 2 * 3.375 GHz	f	-55
f ≥ 36 to 43 GHz	f - 2 * 3.375 GHz	f	-50
f ≥ 43 to 46.2 GHz	f + 2 * 3.375 GHz	f	-40
f ≥ 46.2 to 50 GHz	f - 2 * 3.375 GHz	f	-40
f ≥ 50 GHz	f - 2 * 3.375 GHz	f	-40
f < 2.6 GHz	f + 3.375 GHz / 2	f	-90
f ≥ 2.6 to 7.5 GHz	f + 10.125 GHz / 2	f	-65
f ≥ 7.5 to 9.5 GHz	f + 3.375 GHz / 2	f	-80
f ≥ 9.5 to 15.7 GHz	f + 3.375 GHz / 2	f	-75
f ≥ 15.7 to 19.5 GHz	f + 3.375 GHz / 2	f	-85
f ≥ 19.5 to 26.5 GHz	f - 3.375 GHz / 2	f	-80
f ≥ 26.5 to 29 GHz	f + 3.375 GHz / 2	f	-60
f ≥ 29 to 32.5 GHz	f + 3.375 GHz / 2	f	-65
f ≥ 32.5 to 36 GHz	f - 3.375 GHz / 2	f	--55
f ≥ 36 to 39.5 GHz	f - 3.375 GHz / 2	f	-60
f ≥ 39.5 to 43 GHz	f - 3.375 GHz / 2	f	-65
f ≥ 43 to 46.2 GHz	f + 3.375 GHz / 2	f	-70
f ≥ 46.2 to 50 GHz	f - 3.375 GHz / 2	f	-70
f ≥ 50 GHz	f - 3.375 GHz / 2	f	-75
f ≥ 26.5 to 32.5 GHz	f + 2 * 1.125 GHz	f	-85

Input related responses (dBc)			Nominal
Tuned frequency (f)	Excitation frequency	Spur frequency	N995xB, N996XB
fOffset = frequency offset of excitation frequency from tuned frequency (f)			
f < 2.6 GHz,	f + fOffset	f - fOffset	-70
f > 7.5 GHz to 19.5 GHz,	f + fOffset	f - 2 * (37.5 MHz - fOffset)	-65
f > 26.5 GHz to 32.5 GHz,	f + fOffset	f + 2 * (112.5 MHz + fOffset)	-60
f > 43 GHz to 46.2 GHz	f + fOffset, (fOffset < 0)	f - 6 * (37.5 MHz - fOffset)	-75
	f + fOffset, (fOffset > 0)	f - 6 * (12.5 MHz + fOffset)	-75
f > 2.6 GHz to 7.5 GHz,	f + fOffset	f - fOffset	-70
f > 19.5 GHz to 26.5 GHz,	f + fOffset	f + 2 * (37.5 MHz - fOffset)	-65
f > 32.5 GHz to 43 GHz,	f + fOffset	f - 2 * (112.5 MHz + fOffset)	-65
f > 46.2 GHz	f + fOffset, (fOffset > 0)	f + 6 * (37.5 MHz - fOffset)	-75
	f + fOffset, (fOffset < 0)	f + 6 * (12.5 MHz + fOffset)	-75
f < 2.6 GHz,	f + fOffset	f - n * fOffset, (n = 1, 2, 3, ...)	-75
f > 7.5 GHz to 19.5 GHz,	f + fOffset	f - 2 * (5.625 MHz ± fOffset)	-70
f > 26.5 GHz to 32.5 GHz,	f + fOffset	f - n * fOffset, (n = 1, 2, 3, ...)	-75
f > 43 GHz to 46.2 GHz	f + fOffset	f + 2 * (5.625 MHz ± fOffset)	-70

## IQA (continued)

### Dynamic range specifications (wideband path) (continued)

<b>Spur free dynamic range (dB) at 2.4 GHz 2/3 (TOI - DANL)</b>		<b>Nominal</b>
N991xB, N993xB, N995xB, N996xB		> 106
<b>Third order intermodulation distortion (TOI) – (dBm)</b>		<b>Typical</b>
Two -20 dBm signals, 100 kHz spacing at mixer input (-10 to 55 °C)		
<b>N991xB, N993xB</b>	50 MHz to 500 MHz	+5.8
	≥ 500 to 2 GHz	+7.8
	≥ 2 to 2.4 GHz	+9.8
	≥ 2.4 to 2.6 GHz	+8.3
	≥ 2.6 to 5 GHz	+6.3
	≥ 5 to 7.5 GHz	+7
	≥ 7.5 to 10 GHz	+6.8
	≥ 10 to 18 GHz	+8.5
	≥ 18 to 26.5 GHz	+11.4
<b>Two -20 dBm signals, 100 kHz spacing at mixer input, Ref. level = -10 dBm</b>		<b>Nominal</b>
<b>N995xB, N996xB</b>	50 to 500 MHz	+10
	≥ 500 MHz to 1.4 GHz	+9.5
	≥ 1.4 to 2.4 GHz	+13
	≥ 2.4 to 2.42 GHz	+13.5
	≥ 2.42 to 2.6 GHz	+13
	≥ 2.6 to 7.5 GHz	+10.5
	≥ 7.5 to 9.5 GHz	+10
	≥ 9.5 to 16.3 GHz	+10.5
	≥ 16.3 to 19.5 GHz	+10.5
	≥ 19.5 to 23 GHz	+12
	≥ 23 to 26.5 GHz (all >23 GHz tested with 2 MHz spacing)	+14
	≥ 26.5 to 32 GHz	+8
	≥ 32 to 36 GHz	+7.5
	≥ 36 to 40 GHz	+11
	≥ 40 to 44 GHz	+17
	≥ 44 to 54 GHz	+20

#### Traces

Number of windows & layout	1, 2 (top & bottom), 3 (one top, two bottom), or 4 (quad display)
Number of traces	4, all four traces can be active simultaneously in all windows
States	Clear/write, max hold, min hold, average, view, blank

#### Markers

Number of markers	6 normal + delta pairs
-------------------	------------------------

<b>Traces</b>	
Type	Normal, delta, peak, marker table (up to 6 markers)
Couple markers	On/off (couple markers between traces in different windows)
Mkr →	Peak, next peak, center frequency, reference level
<b>Trigger</b>	
Trigger type	Free run, external, video, RF burst, periodic
Trigger slope	Positive edge, negative edge
Trigger delay	Range: -150 ms to 500 ms Resolution: 100 ns
Auto trigger	Forces a periodic acquisition in the absence of a trigger event Range: 0 (off) to 30 s
<b>Data storage</b>	
Data types	Trace, Trace+state, picture (PNG)
I/Q capture data file types	CSV, text (TXT), SDF (compatible with 89600 VSA software), Matlab (MAT)
I/Q data formats via SCPI	Raw binary interleaved I/Q data recording, REAL32 (ASCII is default)

## Noise Figure (NF) (Option 356)

The specifications in this section apply to the noise figure measurement capabilities available in the following models:

FieldFox RF & microwave (combination) analyzers:	N9913B, N9914B, N9915B, N9916B, N9917B, N9918B
FieldFox RF & microwave signal analyzers:	N9933B, N9934B, N9935B, N9936B, N9937B, N9938B
FieldFox microwave (combination) analyzers:	N9950B, N9951B, N9952B, N9953B
FieldFox microwave signal analyzers:	N9960B, N9961B, N9962B, N9963B

See [FieldFox Configuration Guide](#) for option information. Many capabilities listed in this Data Sheet require options.

No warm-up is required for the instrument specifications.

	Models	Noise figure analysis frequency range
<b>N991xB, N993xB</b>	N9913B, N9933B	10 MHz to 4 GHz
	N9914B, N9934B	10 MHz to 6.5 GHz
	N9915B, N9935B	10 MHz to 9 GHz
	N9916B, N9936B	10 MHz to 14 GHz
	N9917B, N9937B	10 MHz to 18 GHz
	N9918B, N9938B	10 MHz to 26.5 GHz
<b>N995xB, N996xB</b>	N9950B, N9960B	10 MHz to 32 GHz
	N9951B, N9961B	10 MHz to 44 GHz
	N9952B, N9962B	10 MHz to 50 GHz
	N9953B, N9963B	10 MHz to 54 GHz

## NF (continued)

Measurements			
Noise figure	Noise figure (F dB)		
Noise factor	Noise figure as a ratio (F)		
Gain	Gain (G dB)		
Noise temperature	Noise temperature in Kelvin (K)		
Y-factor	Y-factor (Y dB)		
Setup parameters		Supplemental information	
Noise source			Load ENR value(s)
DUT type	Amplifier, Downconverter, Upconverter, Multi-stage Converter		Built-in GUI wizard aids DUT measurement setup
Integration	Mode	Auto	Auto Integration: optimizes gain to avoid compression, and measurement time to achieve jitter goal
		Fixed	Fixed Integration: the time per point over which the measurement is averaged is fixed
	Jitter goal		Sets measurement jitter performance target
	Max time / point		Allows user to trade-off jitter vs. measurement time
	Jitter warning		On: displays circles on trace data if jitter goal is exceeded Off (default): disables trace circle indicators
Loss compensation	Before DUT, After DUT		User definable, compensates measurement for loss (dB) before and after DUT
Measurement bandwidth (nominal)			
Range	5 MHz (default), 3 MHz, 1 MHz, 300 kHz		
Frequency reference			
		Refer to spectrum analyzer specifications	
Noise figure uncertainty calculator <sup>1</sup>		Supplemental information	
		Built-in Based on data from measurement	
DUT	Mode	Spot	Applies single values uniformly across frequency: Input $ \Gamma $ and Output $ \Gamma $ $\Gamma$ specification style: Maximum, 95th percentile, 80th percentile, Median, Mean, Fixed $\Gamma$ distribution: Rayleigh, Fixed, Uniform in Circle
		Table	Applies a table of values vs. frequency: Input $ \Gamma $ and Output $ \Gamma $ $\Gamma$ specification style: Maximum, 95th percentile, 80th percentile, Median, Mean, Fixed $\Gamma$ distribution: Rayleigh, Fixed, Uniform in Circle
Preamplifier	Mode	Spot	Applies single values uniformly across frequency Input $ \Gamma $ and Output $ \Gamma $ $\Gamma$ specification style: Maximum, 95th percentile, 80th percentile, Median, Mean, Fixed $\Gamma$ distribution: Rayleigh, Fixed, Uniform in Circle
		Table	Applies a table of values vs. frequency: Input $ \Gamma $ and Output $ \Gamma $ $\Gamma$ specification style: Maximum, 95th percentile, 80th percentile, Median, Mean, Fixed $\Gamma$ distribution: Rayleigh, Fixed, Uniform in Circle

<sup>1</sup> Keysight provides an on-line NF uncertainty calculator for the FieldFox at <https://www.keysight.com/us/en/assets/9921-01574>

## NF (continued)

Noise figure uncertainty calculator		Supplemental information
		Built-in Based on data from measurement
Noise source	ENR Mode	Applies single values uniformly across frequency: ENR (dB), ENR Uncertainty (dB), On   $\Gamma$  , Off   $\Gamma$  , ENR Uncertainty Confidence (SD) $\Gamma$ specification style: Maximum, 95th percentile, 80th percentile, Median, Mean, Fixed $\Gamma$ distribution: Rayleigh, Fixed, Uniform in Circle
	Spot	
	Table	Applies a table of values vs. frequency: ENR (dB), ENR Uncertainty (dB), On   $\Gamma$  , Off   $\Gamma$  , ENR Uncertainty Confidence (SD) $\Gamma$ specification style: Maximum, 95th percentile, 80th percentile, Median, Mean, Fixed $\Gamma$ distribution: Rayleigh, Fixed, Uniform in Circle
	Smart <sup>1</sup> (Auto)	For U183x USB smart noise sources (SNS) only. When connected with a USB SNS, FieldFox automatically downloads the ENR table data from the SNS and applies a table of values vs. frequency: ENR (dB), ENR Uncertainty (dB), On   $\Gamma$  , Off   $\Gamma$  , ENR Uncertainty Confidence (SD) $\Gamma$ specification style: Maximum, 95th percentile, 80th percentile, Median, Mean, Fixed $\Gamma$ distribution: Rayleigh, Fixed, Uniform in Circle
Uncertainty contributions	Jitter	Random independent events (fluctuations) within the bandwidth occurring during the noise measurement
	ENR	Excess noise ratio of the hot noise source connected to the DUT during the measurement
	Mismatch	Errors resulting from reflections due to impedance differences between components
	User calibration	Errors due to the optional user calibration which is performed with a defined noise standard (ENR source) connected to the input of an LNA, and fixturing/cables used in the DUT measurement, and port 2 of the FieldFox
Uncertainty coverage		User settable, uncertainty coverage can be set to 1 $\sigma$ (80%), 2 $\sigma$ (95% default), 3 $\sigma$ (99.5%)
Uncertainty bars		Displays vertical bars representing the calculated measurement uncertainty overlaid on the trace data
Loss compensation	Before DUT	User definable, single value, compensates measurement for insertion loss (dB) before DUT
	After DUT	User definable, single value, compensates measurement for loss (dB) after DUT
Instrument match		VSWR values are preloaded and automatically applied for instrument and U7227A/C/F or U7228A/C/F preamplifiers
<b>Calibration options</b>		
Receiver calibration		Uses noise source to calibrate FieldFox receiver gain bandwidth
User calibration with external U7227A/C/F or U7228A/C/F preamplifier		Optional calibration performs hot/cold measurement with external preamplifier; applies receiver and user calibrations

<sup>1</sup> Requires FieldFox firmware rev. A. 12.53 or later



## NF (continued)

Noise figure <sup>1</sup>		Internal preamplifier ON	Internal preamplifier ON + U7227/8A	Internal preamplifier ON + U7227/8C
	Frequency	(dB)	(dB)	(dB)
N991xB, N993xB	10 to 100 MHz	13.5	6.1	—
	≥ 100 MHz to 2.1 GHz	13.5	5.6	6.6
	≥ 2.1 to 2.6 GHz	16.5	5.9	6.9
	≥ 2.6 to 4 GHz	14.5	5.5	6.6
	≥ 4 to 4.5 GHz	14.5	—	5.7
	≥ 4.5 to 6 GHz	16.5	—	6.0
	≥ 6 to 7.5 GHz	16.5	—	5.2
	≥ 7.5 to 13 GHz	15.5	—	4.9
	≥ 13 to 18 GHz	18.5	—	5.2
	≥ 18 to 22 GHz	19.5	—	5.9
	≥ 22 to 25 GHz	21.5	—	6.1
≥ 25 to 26.5 GHz	24.5	—	6.7	

Noise figure <sup>1</sup>		Internal preamplifier ON	Internal preamplifier ON + U7227/8F <sup>2</sup>
	Frequency	(dB)	(dB)
N991xB, N993xB	≥ 2.1 to 2.6 GHz	16.5	10.4
	≥ 2.6 to 4 GHz	14.5	8.4
	≥ 4 to 4.5 GHz	14.5	8.3
	≥ 4.5 to 7.5 GHz	16.5	8.5
	≥ 7.5 to 13 GHz	15.5	8.4
	≥ 13 to 18 GHz	18.5	8.5
	≥ 18 to 22 GHz	19.5	8.5
	≥ 22 to 25 GHz	21.5	8.6
	≥ 25 to 26.5 GHz	24.5	9.0

<sup>1</sup> Noise figure (NF) = DANL - (-173.98 - 2.51) dB

Nominal calculation is based on spectrum analyzer (SA) displayed average noise level (DANL) specification (dBm) stated as input terminated, RMS detection, log averaging, 0 dB input attenuation, reference level of -20 dBm, normalized to 1 Hz RBW.

Noise figure (NF) = D - (K - L), where D is the DANL (displayed average noise level) specification, K is kTB (-173.98 dBm in a 1 Hz bandwidth at 290 K), and L is 2.51 dB (the effect of log averaging used in DANL verifications).

<sup>2</sup> U7227/8F maximum frequency is 50 GHz; can be used with N991xB or N993xB up to maximum frequency of 26.5 GHz.

## NF (continued)

Noise figure <sup>1</sup>		Internal preamplifier ON	Internal preamplifier ON + U7227/8A	Internal preamplifier ON + U7227/8C
	Frequency	(dB)	(dB)	(dB)
N995xB, N996xB	10 to 100 MHz	13.5	6.1	—
	≥ 100 MHz to 2.1 GHz	13.5	5.5	6.5
	≥ 2.1 to 4 GHz	15.5	5.9	6.8
	≥ 4 to 6 GHz	15.5	—	5.9
	≥ 6 to 7.5 GHz	15.5	—	4.9
	≥ 7.5 to 13 GHz	15.5	—	4.9
	≥ 13 to 18 GHz	21.5	—	7.0
	≥ 18 to 26.5 GHz	21.5	—	6.4
	≥ 26.5 to 32 GHz	16.5	—	—
	≥ 32 to 40 GHz	20.5	—	—
	≥ 40 to 44 GHz	25.5	—	—
	≥ 44 to 50 GHz	32.5	—	—
≥ 50 to 54 GHz	37.5	—	—	

Noise figure <sup>1</sup>		Internal preamplifier ON	Internal preamplifier ON + U7227/8F
	Frequency	(dB)	(dB)
N995xB, N996xB	≥ 2.1 to 4 GHz	15.5	10.3
	≥ 4 to 6 GHz	15.5	8.4
	≥ 6 to 7.5 GHz	15.5	8.4
	≥ 7.5 to 13 GHz	15.5	8.4
	≥ 13 to 18 GHz	21.5	9.4
	≥ 18 to 26.5 GHz	21.5	9.4
	≥ 26.5 to 32 GHz	16.5	8.5
	≥ 32 to 40 GHz	20.5	9.2
	≥ 40 to 44 GHz	25.5	9.5
	≥ 44 to 50 GHz	32.5	11.3
≥ 50 to 54 GHz	37.5	—	

<sup>1</sup> Noise figure (NF) = DANL - (-173.98 - 2.51) dB

Nominal calculation is based on spectrum analyzer (SA) displayed average noise level (DANL) specification (dBm) stated as input terminated, RMS detection, log averaging, 0 dB input attenuation, reference level of -20 dBm, normalized to 1 Hz RBW.

Noise figure (NF) = D - (K - L), where D is the DANL (displayed average noise level) specification, K is kTB (-173.98 dBm in a 1 Hz bandwidth at 290 K), and L is 2.51 dB (the effect of log averaging used in DANL verifications).

## NF (continued)

External preamplifier			
Specification	U7227/8A	U7227/8C	U7227/8F
Frequency	10 MHz to 4 GHz	100 MHz to 26.5 GHz	2 GHz to 50 GHz
Noise figure (dB)	10 MHz to 100 MHz: < 5.5 100 MHz to 4 GHz: < 5	100 MHz to 4 GHz: < 6 4 to 6 GHz: < 5 6 to 18 GHz: < 4 18 to 26.5 GHz: < 5	2 to 4 GHz: < 10 4 to 40 GHz: < 8 40 to 44 GHz: < 9 44 to 50 GHz: < 10
Gain (dB)	10 to 100 MHz: > 16 100 MHz to 4 GHz: > 0.5F <sup>1</sup> + 17	100 MHz to 26.5 GHz: > 16.1 + 0.26F <sup>1</sup>	2 GHz to 50 GHz: > 16.5 + 0.23F <sup>1</sup>
RF connector	3.5 mm (m)	3.5 mm (m)	2.4 mm (m)
Noise source			
Model	Frequency range	ENR	
<b>Keysight 346 noise source family</b>			
346A	10 MHz to 18 GHz	5 to 7 dB	
346B	10 MHz to 18 GHz	14 to 16 dB	
346C	10 MHz to 26.5 GHz	12 to 17 dB	
346CK40	1 GHz to 40 GHz	3 to 14 dB	
346CK01	1 GHz to 50 GHz	7 to 20 dB	
<b>Keysight USB smart noise source (SNS) family<sup>2</sup></b>			
U1832A	10 MHz to 18 GHz	4.5 to 6.5 dB	
U1832B	10 MHz to 26.5 GHz	4 to 7 dB	
U1833A	10 MHz to 18 GHz	14 to 16 dB	
U1833B	10 MHz to 26.5 GHz	12 to 17 dB	
U1832C	500 MHz to 50 GHz	3.5 to 8.5 dB	
U1833C	500 MHz to 50 GHz	10 to 21 dB	
U1833D	500 MHz to 60 GHz	6 to 21 dB	
Noise source setup		Supplemental info	
ENR Mode	Spot	Single ENR value (not frequency dependent) (default: 15 dB)	
	Table	Applies table of ENR values vs. frequency Create, save, recall, edit ENR tables; File type: .ENR	
	Smart <sup>2</sup> (Auto)	For U183x USB SNS only. When connected with a USB SNS, FieldFox updates the T cold value at beginning of every sweep, and automatically loads the ENR file from the USB SNS	
T cold	Auto (default) or Manual	Noise temperature of cold noise standard connected to DUT during the measurement	
Connector type	SMB (m)	DC bias requires accessory N9910X-713 BNC to SMB cable, for 346 noise source only	
	USB 3.0 (Type C)	For U183x USB SNS only	
Control voltage drive level	28 ± 1 V	For 346 noise source only, no need for U183x USB SNS	
Operating temperature	0 to 55 °C		

<sup>1</sup> F signifies frequency in GHz.

<sup>2</sup> Requires FieldFox firmware rev. A.12.53 or later

## NF (continued)

<b>Sweep</b>	
Number of points	11 (default), 21, 51, 101, 201, 401, 601, 801, 1001
Sweep mode	Continuous or single
<b>DUT profiles available (built-in GUI wizard aids DUT measurement setup)</b>	
Amplifier	Includes any non-frequency-converting device
Downconverter	Frequency context can be set to RF or IF; sideband can be set to LSB, USB, DSB
Upconverter	Frequency context can be set to RF or IF; sideband can be set to LSB, USB, DSB
Multi-stage converter	Frequency context can be set to RF or IF
<b>Display formats</b>	
Number of traces	Two traces available
Display formats	Single-trace Dual-trace overlay (both traces on one graticule) Dual-trace split (each trace on separate top and bottom graticules)
Display data	Display data, memory, data and memory
Trace memory	One memory trace per data trace, total of 2 memory traces
Limit lines	Upper and lower for each trace
<b>Markers</b>	
Number of markers	6
Type	Normal, Delta, Marker Table
Marker table	Display 6 markers
Mkr →	Peak, Next Peak, Peak Left, Peak Right, Center Frequency, Reference Level, Minimum, Target
<b>Data storage</b>	
Data types	Trace, Trace+State, Picture (PNG), CSV

The performance listed in these sections below applies to the spectrum analyzer IF output, preamplifier, interference analyzer and spectrogram, channel scanner and 89600 VSA software capabilities available in the following models:

FieldFox RF & microwave (combination) analyzers:	N9913B, N9914B, N9915B, N9916B, N9917B, N9918B
FieldFox RF & microwave signal analyzers:	N9933B, N9934B, N9935B, N9936B, N9937B, N9938B
FieldFox microwave (combination) analyzers	N9950B, N9951B, N9952B, N9953B
FieldFox microwave signal analyzers	N9960B, N9961B, N9962B, N9963B

See [FieldFox Configuration Guide](#) for option information. Many capabilities listed in this Data Sheet require options.

## Spectrum Analyzer IF Output

Spectrum analyzer mode, zero span, IF output settings <sup>1</sup>			
Bandwidth options	10 MHz (Standard)	40 MHz (Opt B04)	120 MHz (Opt B10)
IF output mode (Narrow)			
Center frequency	33.75 MHz	33.75 MHz	33.75 MHz
IF bandwidth	10 MHz	10 MHz	10 MHz
IF output mode (Wide)			
Center frequency	—	225 MHz	225 MHz
IF bandwidth	—	100 MHz	100 MHz

Conversion gain <sup>2</sup>	Center frequency	Narrowband path	Wideband path
N991xB, N993xB	< 120 MHz	2 dB to -1 dB	6 dB to 3 dB
	≥ 120 MHz to 7.5 GHz	6 dB to -2 dB	13 dB to 4 dB
	≥ 7.5 GHz to 26.5 GHz	6 dB to -6 dB	13 dB to 0 dB
N995xB, N996xB	< 120 MHz	7 dB to -5 dB	16 dB to 0 dB
	≥ 120 MHz to 7.5 GHz	6 dB to -6 dB	13 dB to 3 dB
	≥ 7.5 GHz to 26.5 GHz	10 dB to -9 dB	17 dB to 4 dB
	≥ 26.5 GHz to 40 GHz	10 dB to -9 dB	18 dB to 2 dB
	≥ 40 GHz to 54 GHz	3 dB to -24 dB	10 dB to -12 dB
Connector	SMB male		

## Preamplifier (Option 235)

		Nominal
Frequency range		Full band (9 kHz to maximum frequency of instrument)
Gain	N991xB, N993xB	+20 dB, 9 kHz to 26.5 GHz
	N995xB, N996xB	+15 dB, 9 kHz to 54 GHz

<sup>1</sup> Measurements are uncalibrated in IF output mode.

<sup>2</sup> RF input to SA output with -20 dBm input power, 0 dB attenuation, and preamp off.

## Interference Analyzer and Spectrogram (Option 236)

	Description
Spectrogram display	Overlay, full screen, top, or bottom with active trace
Waterfall angle	Moderate, steep, gradual, wide angle
Markers	Time, delta time
Trace playback and recording	<ul style="list-style-type: none"><li>-Record all spectrum analyzer measurements</li><li>-Playback recorded data using FieldFox</li><li>-Frequency mask trigger allows recording to occur upon trigger</li><li>-Store data internally or USB or SD card</li></ul>

## Channel Scanner (Option 312)

	Description
Scan Mode	Range or custom list
Display Type	Bar chart vertical, bar chart horizontal, channel power, strip chart, chart overlay, scan & listen
Data logging mode	Time with geo tagging
Trace playback and recording	<ul style="list-style-type: none"><li>-Record channel power measurement</li><li>-Playback recorded data using FieldFox</li><li>-Store data internally or USB or SD card in .csv or .kml format</li><li>-Data in .kml format can be exported to Google Earth</li></ul>

## 89600 VSA Software

Bandwidth options	10 MHz (Standard) Nominal	40 MHz (Opt B04) Nominal <sup>1</sup>	120 MHz (Opt B10) Nominal <sup>1</sup>
<b>N991xB, N993xB</b>			
EVM (at center frequency 1 GHz)			
5G NR 64 QAM	—	—	0.70%
LTE-A FDD TM3.1 (10 MHz)	0.50%	0.50%	0.50%
LTE-A FDD TM3.1 (20 MHz)	—	0.40%	0.40%
WCDMA TM4 (5 MHz)	0.70%	0.70%	0.70%
EVM (at center frequency 2.1 GHz)			
LTE-A FDD TM3.1 (10 MHz)	0.70%	0.70%	0.70%
LTE-A FDD TM3.1 (20 MHz)	—	0.50%	0.50%
WCDMA TM4 (5 MHz)	0.75%	0.75%	0.75%
EVM (at center frequency 3.5 GHz)			
5G NR 64 QAM	—	—	0.85%
LTE-A FDD TM3.1 (20 MHz)	—	0.80%	0.80%
EVM (at center frequency 5.8 GHz)			
5G NR 64 QAM	—	—	1%
EVM (at center frequency 24 GHz)			
5G NR 64 QAM	—	—	2%
<b>N995xB, N996xB</b>			
EVM (at center frequency 1 GHz)			
5G NR 64 QAM	—	—	0.70%
LTE-A FDD TM3.1 (10 MHz)	0.50%	0.50%	0.50%
LTE-A FDD TM3.1 (20 MHz)	—	0.60%	0.40%
WCDMA TM4 (5 MHz)	0.64%	0.70%	0.70%
EVM (at center frequency 2.1 GHz)			
LTE-A FDD TM3.1 (10 MHz)	0.65%	0.65%	0.65%
LTE-A FDD TM3.1 (20 MHz)	—	0.60%	0.50%
WCDMA TM4 (5 MHz)	0.87%	0.75%	0.75%
EVM (at center frequency 3.5 GHz)			
5G NR 64 QAM	—	—	0.80%
LTE-A FDD TM3.1 (20 MHz)	—	0.80%	0.80%
EVM (at center frequency 5.8 GHz)			
5G NR 64 QAM	—	—	1%
EVM (at center frequency 24 GHz)			
5G NR 64 QAM	—	—	2.2%
EVM (at center frequency 28 GHz)			
5G NR 64 QAM	—	—	2.1%
EVM (at center frequency 39 GHz)			
5G NR 64 QAM	—	—	2.3%

<sup>1</sup> Applies when fast channel equalization (default) is OFF.

## Over-the-Air (OTA) LTE FDD/TDD (Option 370/371)

The performance listed in this section applies to the OTA analyzer capabilities available in the following models:

FieldFox RF & microwave (combination) analyzers:	N9913B, N9914B, N9915B, N9916B, N9917B, N9918B
FieldFox RF & microwave signal analyzers:	N9933B, N9934B, N9935B, N9936B, N9937B, N9938B
FieldFox microwave (combination) analyzers	N9950B, N9951B, N9952B, N9953B
FieldFox microwave signal analyzers	N9960B, N9961B, N9962B, N9963B

See [FieldFox Configuration Guide](#) for option information. Many capabilities listed in this Data Sheet require options.

	Models	OTA analysis frequency range <sup>1</sup>
<b>N991xB, N993xB</b>	N9913B, N9933B	1 MHz to 4 GHz
	N9914B, N9934B	1 MHz to 6.5 GHz
	N9915B, N9935B	1 MHz to 9 GHz
	N9916B, N9936B	1 MHz to 14 GHz
	N9917B, N9937B	1 MHz to 18 GHz
	N9918B, N9938B	1 MHz to 26.5 GHz
<b>N995xB, N996xB</b>	N9950B, N9960B	1 MHz to 32 GHz
	N9951B, N9961B	1 MHz to 44 GHz
	N9952B, N9962B	1 MHz to 50 GHz
	N9953B, N9963B	1 MHz to 54 GHz

### LTE FDD/TDD Over-the-Air (OTA) Measurements<sup>2</sup>

Cell scan results	Frequency PCI (Physical Cell Identifier) (C/S/G) RSRP (Reference Signal Received Power) (dBm) RSRQ (Reference Signal Received Quality) (dB) RSSI (Reference Signal Strength Indicator) (dBm) PSS (Primary Synchronization Signal) (dBm) SSS (Secondary Synchronization Signal) (dBm) SINR (Signal to Interference & Noise Ratio) (dB) Freq Err (Frequency Error) (Hz)
Data formats	User can set up and display 1, 2, 3 or 4 simultaneous measurements of key performance indicators (KPI's) for any component carrier (CC0 through CC4), up to 5 carriers, in any combination of the following:
Table	Cell scan numeric results (for up to 6 cell sites (ID's) including PCI (C/S/G), RSRP, RSRQ, RSSI, PSS, SSS, SINR, Freq Err
Bar chart	Vertical power bar graph of selectable cell scan results for up to 6 cell sites with adjustable color "heat" amplitude scale
Spectrum	Magnitude spectrum frequency domain (fixed span)
Strip chart	Magnitude of selectable cell scan results graphed over time

<sup>1</sup> Performance specified above 1 MHz. Usable down to 5 kHz.

<sup>2</sup> For center frequency signals above 1 GHz, the built-in GPS receiver (Option 307) is highly recommended or locking to any 10 MHz frequency reference. When locked to GPS as the frequency reference, this provides accuracy of  $\pm 0.01$  ppm (spec).



## OTA LTE FDD/TDD (continued)

Setup parameters	
Component carrier	CC0 to CC4
Channel table	Sets frequency based on band and channels
Favorites list	Save up to 6 favorite cellular bands/channels
Window configuration	Any combination of 1, 2, 3, or all 4 windows can be displayed simultaneously: 1, 2 (top & bottom), 3 (one top, two bottom), or 4 (quad display)
Trigger	
Trigger type	Free run, external
Record / Playback	
Data logging	Record, recall and playback data for all component carrier(s)
Record settings	Meas Interval, Interval type (time or distance), time interval, distance interval
Supported file types	CSV, KML
Saving data	Save/recall recorded data logs to/from internal memory or external USB or SD card

## Over-the-Air (OTA) 5G TF (Option 377)

The performance listed in this section applies to the OTA analyzer capabilities available in the following models:

FieldFox RF & microwave (combination) analyzers:	N9913B, N9914B, N9915B, N9916B, N9917B, N9918B
FieldFox RF & microwave signal analyzers:	N9933B, N9934B, N9935B, N9936B, N9937B, N9938B
FieldFox microwave (combination) analyzers:	N9950B, N9951B, N9952B, N9953B
FieldFox microwave signal analyzers:	N9960B, N9961B, N9962B, N9963B

See [FieldFox Configuration Guide](#) for option information. Many capabilities listed in this Data Sheet require options.

	Models	OTA analysis frequency range <sup>1</sup>
<b>N991xB, N993xB<sup>2</sup></b>	N9913B, N9933B	1 MHz to 4 GHz
	N9914B, N9934B	1 MHz to 6.5 GHz
	N9915B, N9935B	1 MHz to 9 GHz
	N9916B, N9936B	1 MHz to 14 GHz
	N9917B, N9937B	1 MHz to 18 GHz
	N9918B, N9938B	1 MHz to 26.5 GHz
<b>N995xB, N996xB</b>	N9950B, N9960B	1 MHz to 32 GHz
	N9951B, N9961B	1 MHz to 44 GHz
	N9952B, N9962B	1 MHz to 50 GHz
	N9953B, N9963B	1 MHz to 54 GHz

<sup>1</sup> Performance specified above 1 MHz. Usable down to 5 kHz.

<sup>2</sup> Requires external mixer to down convert millimeter wave frequency to intermediate frequency (IF).

## 5G TF Over-the-Air (OTA) measurements<sup>1</sup>

Cell scan results	Center frequency PCI (Physical Cell Identifier) Power (Channel Power) (dBm) PSS (Primary Synchronization Signal) (dBm) SSS (Secondary Synchronization Signal) (dBm) Sync Corr (Sync Correlation) (%)
-------------------	---

<b>Data formats</b>	User can setup and display 1, 2, 3 or 4 simultaneous measurements of key performance indicators (KPI's) for any component carrier (CC0 through CC7), up to 8 carriers, in any combination of the following:
Table	Cell scan numeric results (for up to 6 cell sites (ID's) including Cell ID, Channel Power, PSS, SSS, Sync Corr
Bar chart	Vertical power bar graph of selectable cell scan results for up to 8 cell sites with adjustable color "heat" amplitude scale
Spectrum	Magnitude spectrum frequency domain (fixed span)
Strip chart	Magnitude of selectable cell scan results graphed over time

---

Signal bandwidth	Up to 10 MHz
------------------	--------------

### Setup parameters

Component carrier	CC0 to CC7
Channel table	Sets frequency based on band and channel
Window configuration	Any combination of 1, 2, 3, or all 4 windows can be displayed simultaneously: 1, 2 (top & bottom), 3 (one top, two bottom), or 4 (quad display)

### Trigger

Trigger type	Free run, external
--------------	--------------------

### Record / Playback

Data logging	Record, recall and playback data for all component carrier(s)
Record settings	Meas Interval, Interval type (time or distance), time interval, distance interval
Supported file types	CSV, KML
Saving data	Save/recall recorded data logs to/from internal memory or external USB or SD card

---

<sup>1</sup> For center frequency signals above 1 GHz, the built-in GPS receiver (Option 307) is highly recommended or locking to any 10 MHz frequency reference. When locked to GPS as the frequency reference, this provides accuracy of  $\pm 0.01$  ppm (spec).

## Over-the-Air (OTA) 5G NR (Option 378)

The performance listed in this section applies to the OTA analyzer capabilities available in the following models:

FieldFox RF & microwave (combination) analyzers:	N9913B, N9914B, N9915B, N9916B, N9917B, N9918B
FieldFox RF & microwave signal analyzers:	N9933B, N9934B, N9935B, N9936B, N9937B, N9938B
FieldFox microwave (combination) analyzers:	N9950B, N9951B, N9952B, N9953B
FieldFox microwave signal analyzers:	N9960B, N9961B, N9962B, N9963B

See [FieldFox Configuration Guide](#) for option information. Many capabilities listed in this Data Sheet require options.

	Models	OTA analysis frequency range <sup>1</sup>
<b>N991xB, N993xB</b>	N9913B, N9933B	1 MHz to 4 GHz
	N9914B, N9934B	1 MHz to 6.5 GHz
	N9915B, N9935B	1 MHz to 9 GHz
	N9916B, N9936B	1 MHz to 14 GHz
	N9917B, N9937B	1 MHz to 18 GHz
	N9918B, N9938B	1 MHz to 26.5 GHz
<b>N995xB, N996xB</b>	N9950B, N9960B	1 MHz to 32 GHz
	N9951B, N9961B	1 MHz to 44 GHz
	N9952B, N9962B	1 MHz to 50 MHz
	N9953B, N9963B	1 MHz to 54 MHz

<sup>1</sup> Performance specified above 1 MHz. Usable down to 5 kHz.

## OTA 5G NR (continued)

### 5G NR Measurements<sup>1</sup>

5G NR Over-the-Air (OTA)

Cell scan results

Frequency

PCI (Physical Cell Identifier) (C-S-G) (Cell ID-Sector ID-Group ID)

SSB Index (Synchronization Signal Block Index)

SS-RSRP (Synchronization Signal Reference Signal Received Power) (dBm)

SS-RSRQ (Synchronization Signal Reference Signal Received Quality) (dB)

RSSI (Received Signal Strength Indicator) (dBm)

SS-SINR (Synchronization Signal Signal-to-Noise and Interference Ratio) (dB)

PSS (Primary Synchronization Signal) (dBm)

SSS (Secondary Synchronization Signal) (dBm)

PBCH DMRS (Physical Broadcast Channel Demodulation Reference Signal) (dBm)

Freq Err (Frequency Error) (Hz)

5G NR EVM Conducted

Cell scan results

Frequency

PCI (Physical Cell Identifier)

SSB Numerology (Synchronization Signal Block Numerology)

SSB Case (Synchronization Signal Block Case)

SSB Lmax (Maximum Number SSB's within SSB Set, Lmax = 4, 8 or 64)

SSB Periodicity (ms)

SSB RB Offset (Synchronization Signal Block Resource Block Offset)

SSB SC Offset (Synchronization Signal Block Subcarrier Offset)

SSB Delta Center (Synchronization Signal Block Delta Center) (kHz) <sup>2</sup>

Sync Corr (Synchronization Correlation) (%)

Channel Power (dBm)

Freq Err (Frequency Error) (Hz)

Time Offset (ms)

PSS EVM (Primary Synchronization Signal EVM) (%rms)

SSS EVM (Secondary Synchronization Signal EVM) (%rms)

PBCH EVM (Physical Broadcast Channel EVM) (%rms)

PBCH DMRS EVM (Physical Broadcast Channel Demodulation Reference Signal EVM) (%rms)

Composite EVM (%rms)

SS-RSRP (Synchronization Signal Reference Signal Received Power) (dBm)

SS-RSRQ (Synchronization Signal Reference Signal Received Quality) (dB)

RSSI (Reference Signal Strength Indicator) (dBm)

PSS Power (Primary Synchronization Signal Power) (dBm)

SSS Power (Secondary Synchronization Signal Power) (dBm)

PBCH Power (Physical Broadcast Channel Power) (dBm)

PCBCH DMRS Power (Physical Broadcast Channel Demodulation Reference Signal Power) (dBm)

Signal bandwidth

Up to 100 MHz (Requires Option B10)

Component carrier

CC0 to CC7 (5G NR over-the-air (OTA) measurements)

CC0 to CC4 (5G NR conducted EVM measurements)

<sup>1</sup> For center frequency signals above 1 GHz, the built-in GPS receiver (Option 307) is highly recommended or locking to any 10 MHz frequency reference. When locked to GPS as the frequency reference, this provides accuracy of  $\pm 0.01$  ppm (spec).

<sup>2</sup> Synchronization Signal Block Subcarrier Offset is the offset of the Synchronization Signal Block from the center of the channel.

## 5G NR Measurements<sup>1</sup>

Data formats	User can set up and display 1, 2, 3 or 4 simultaneous measurements of key performance indicators (KPI's) for any component carrier, in any combination of the following <sup>1</sup> :
Table	Cell scan numeric results (for up to 6 cell sites (ID's))
Bar chart	Vertical power bar graph of selectable cell scan results for up to 6 cell sites with adjustable color "heat" amplitude scale
Spectrum	Magnitude spectrum frequency domain (fixed span)
Strip chart	Magnitude of selectable cell scan results graphed over time
Window configuration	Any combination of 1, 2, 3, or all 4 windows can be displayed simultaneously: 1, 2 (top & bottom), 3 (one top, two bottom), or 4 (quad display)

## Setup parameters

### 5G NR Over-the-Air (OTA)

Frequency error threshold	0 Hz to 7.5 kHz <sup>2</sup>
Subcarrier spacing	15 kHz, 30 kHz, 120 kHz, 240 kHz
SSB case	Auto, A, B, C, D, E
Lmax	Auto, 4, 8, 64
Capture length	4, 8, 16, 24, 32 or 40 frames
Drive speed	Low, medium, high
SS Meas DMRS	Off, On
Phase compensation	Off, On
EMF Measurement	Off, On
EMF Units	dB $\mu$ V/m, V/m

### 5G NR Conducted EVM

Cell ID	Auto, Manual
Bandwidth	FR1: 5, 10, 15, 20, 25, 30, 40, 50, 60, 70, 80, 90, 100 MHz FR2: 50, 100 MHz
Subcarrier spacing	15 kHz, 30 kHz, 120 kHz, 240 kHz
Export results	Exports SSB center frequency, SSB subcarrier spacing, SSB Case and SSB Lmax to 5G NR OTA setup

## Trigger

Trigger type	Free run, external, periodic trigger
--------------	--------------------------------------

## Record / Playback

Data logging	Record, recall and playback data for all component carrier(s)
Record settings	Meas Interval, Interval type (time or distance), time interval, distance interval
Supported file types	CSV, KML
Saving data	Save/recall recorded data logs to/from internal memory or external USB or SD card

<sup>1</sup> You can also display the results from multiple component carriers on the table, bar chart, and strip chart displays.

<sup>2</sup> The frequency error threshold is dependent on the SCS - freq err threshold = +/- 1/4 \* SCS (e.g. for 15 kHz, freq err threshold = 3.75 kHz).

## Indoor and Outdoor Mapping (Option 352)

The performance listed in this section applies to the indoor and outdoor mapping capabilities available in the following models:

FieldFox RF & microwave (combination) analyzers:	N9913B, N9914B, N9915B, N9916B, N9917B, N9918B
FieldFox RF & microwave signal analyzers:	N9933B, N9934B, N9935B, N9936B, N9937B, N9938B
FieldFox microwave (combination) analyzers:	N9950B, N9951B, N9952B, N9953B
FieldFox microwave signal analyzers:	N9960B, N9961B, N9962B, N9963B

See [FieldFox Configuration Guide](#) for option information. Many capabilities listed in this Data Sheet require options.

Option 352 adds indoor and outdoor mapping capability to FieldFox analyzers, so that FieldFox can import maps from OpenStreetMap (OSM) for data collection and data plotting to the map directly on the FieldFox instrument display. The FieldFox indoor and outdoor mapping feature resides at the System level and the mapping capability can be enabled within the following modes:

Channel Scanner (Option 312)

Phased Array Antenna Support (Option 360)

Over-the-Air (OTA) LTE FDD/TDD (Option 370/371)

Over-the-Air (OTA) 5GTF (Option 377)

Over-the-Air (OTA) 5G NR (Option 378)

Indoor and outdoor mapping (Option 352) requirements:

Spectrum analyzer mode (Option 233 on N991xB/N995xB, default mode on N993xB/N996xB)

GPS receiver (Option 307), required for outdoor mapping

OSM maps can be saved to the FieldFox internal memory, SD card or USB drive. This can be done via a direct wired LAN connection or OSM maps can be downloaded and saved to FieldFox using the [FieldFox Map Support Tool](#).

	Description
Map coordinates	Latitude, longitude
Map zoom levels	4 to 17
Map icons	Flag, point, line
Map labels	On, Off
Map panorama	North, South, East, West
Data logging	Record, recall and playback
Indoor map file type	PNG

Using a direct wired LAN connection, FieldFox will automatically access OSM once location coordinates (latitude and longitude) and zoom levels are entered the Map Explorer menu. If using the FieldFox Map Support Tool, OSM map files can be downloaded to a .zip file and imported to FieldFox internal memory. If the FieldFox GPS receiver is enabled and OSM maps have been previously saved to FieldFox with those GPS coordinates, FieldFox can automatically load the corresponding map to match the GPS coordinates.

## EMF Measurements (Option 358)

	Description
Supported antenna	AGOS Advanced Technologies, Triaxial Isotropic Antenna Model: SDIA-6000 (or 85572A-006 if ordered directly from Keysight) Frequency coverage: 30 MHz to 6 GHz
Supported operating modes	Spectrum analyzer (Channel Power measurement only) Over-the-Air (OTA) 5G NR
Antenna axis	Average all (Isotropic), X-axis, Y-axis, Z-axis
Units	Spectrum analyzer mode: dBuV/m, dBm/m <sup>2</sup> , V/m, Watt/cm <sup>2</sup> , W/m <sup>2</sup> , dBμA/m, dBG, dBpT Over-the-Air (OTA) 5G NR mode: V/m, dBμV/m
Measurement time	Sweep time acquisition control can be set from 1 to 5000
Data logging	Record, recall and playback data
Supported file types	Spectrum analyzer mode: CSV Over-the-Air (OTA) 5G NR mode: CSV, KML
Saving data	Save/recall recorded data logs to/from internal memory or external USB or SD card

## AM/FM Analog demodulation, Tune and Listen (Option 355)

The performance listed in this section applies to the AM/FM analog demodulation, tune and listen capabilities available in the following models:

FieldFox RF & microwave (combination) analyzers:	N9913B, N9914B, N9915B, N9916B, N9917B, N9918B
FieldFox RF & microwave signal analyzers:	N9933B, N9934B, N9935B, N9936B, N9937B, N9938B
FieldFox microwave (combination) analyzers:	N9950B, N9951B, N9952B, N9953B
FieldFox microwave signal analyzers:	N9960B, N9961B, N9962B, N9963B

See [FieldFox Configuration Guide](#) for option information. Many capabilities listed in this Data Sheet require options.

	Description
Display type	RF spectrum view, demodulated waveform, including peak+ and peak- traces
Audio demodulation type	AM, FM narrow, FM wide, SSB and CW (Morse code), listen to the tones using FieldFox's built-in speaker or headphones
Audio bandwidth	16 kHz
Measurement type	RF carrier power (dBm), RF carrier frequency (Hz), modulation rate (Hz), SINAD (dB), THD (%)
<b>AM &amp; FM metrics</b>	<b>Nominal</b>
SINAD	2.5 dB to 65 dB
THD	0 to 75%
<b>AM measurements</b>	<b>Nominal</b>
Maximum modulation rate	5 kHz, demod sweep time: 50 $\mu$ s to 50 ms
Depth	(peak-to-peak/2) (%), $\pm$ peak depth (%)
Depth accuracy	$\pm$ 2%
Depth range	Modulation: 0.1% to 99%
<b>FM measurements</b>	<b>Nominal</b>
Maximum modulation rate	5 kHz, demod sweep time: 50 $\mu$ s to 50 ms
Frequency deviation	(Hz), $\pm$ peak deviation (Hz)
Maximum deviation	5 MHz (nominal)
<b>Audio record/playback</b>	
	Record audio into WAV file with time stamp and geo tag and playback on PC

## Radio standards

With a radio standard applied, pre-defined frequency bands, channel numbers or uplink / downlink selections can be used instead of manual frequency entry. The pre-defined FieldFox radio standards include bands such as W-CDMA, LTE, and GSM. Alternately, users can create custom standards and import them into FieldFox analyzers.



## Spectrum Analyzer Time Gating (Option 238)

With time gating, you can measure the spectrum of a periodic signal during a specified time interval. Pulsed-RF signals are an example of a periodic signal that can be measured with time gating. For example, you can measure the pulse during the on period, not the transition or the off period. Or you can exclude interfering signals such as a periodic transient. Time gating allows you to view spectral components that would otherwise be hidden. FieldFox's time gating method is a Gated FFT.

	Description
Gate method	Gated FFT
Span range	Any span
RBW range	1 Hz to 300 kHz (derived from gate width)
Gate delay range	-150 ms to 10 s
Gate width (length) range	6 $\mu$ s to 1.8 s
Gate sources	External, RF burst, Video

## Reflection Measurements (RL, VSWR) (Option 320, applicable to SA only models)

The performance listed in this section applies to the reflection measurements capabilities available in the following models:

FieldFox RF & microwave spectrum analyzers:	N9933B, N9934B, N9935B, N9936B, N9937B, N9938B <sup>1</sup>
FieldFox microwave signal analyzers	N9960B, N9961B, N9962B, N9963B

See [FieldFox Configuration Guide](#) for option information. Many capabilities listed in this Data Sheet require options.

	Models	Reflection measurements
<b>N993xB</b>	N9933B	30 kHz to 9 GHz
	N9934B	30 kHz to 9 GHz
	N9935B	30 kHz to 9 GHz
	N9936B	30 kHz to 14 GHz
	N9937B	30 kHz to 18 GHz
	N9938B <sup>1</sup>	30 kHz to 26.5 GHz
<b>N996xB</b>	N9960B	300 kHz to 32 GHz
	N9961B	300 kHz to 44 GHz
	N9962B	300 kHz to 50 GHz
	N9963B	300 kHz to 54 GHz
<b>Measurements</b>		
Return loss, VSWR normalization using data/memory (requires Option 220 tracking generator)		

<sup>1</sup> Reflection measurements in N9938B specifically require 3.5 mm (m) test ports (Option 100) instead of the standard Type-N (f).

## Extended Range Transmission Analysis (ERTA) (Option 209)

ERTA specifications apply to the following FieldFox models. The RF & microwave analyzers must be equipped with the spectrum analyzer option.

FieldFox RF & microwave (combination) analyzers:	N9913B, N9914B, N9915B, N9916B, N9917B, N9918B
FieldFox RF & microwave signal analyzers:	N9933B, N9934B, N9935B, N9936B, N9937B, N9938B
FieldFox microwave (combination) analyzers:	N9950B, N9951B, N9952B, N9953B
FieldFox microwave signal analyzers:	N9960B, N9961B, N9962B, N9963B

ERTA operation requires two FieldFox units, each one configured with specific options, and certain accessories. See [FieldFox Configuration Guide](#) for option information. Many capabilities listed in this Data Sheet require options.

### System description

ERTA can be used to measure the scalar transmission gain or loss of an RF system. It is useful when measuring long lossy cables where the two ends cannot easily be brought together, such as those bolted in on ships or aircrafts. It is also useful in measuring the insertion loss of waveguide systems, or using the frequency-offset feature, devices such as mixers and converters.

ERTA measurements are based on two FieldFox units; one at each end of the measured DUT. One FieldFox is the source and reference receiver (R), while the other is the measurement receiver (B). The two FieldFox units are synchronized using hardware triggering. By taking advantage of FieldFox's InstAlign technique, ERTA can be used to make accurate gain or loss measurements.

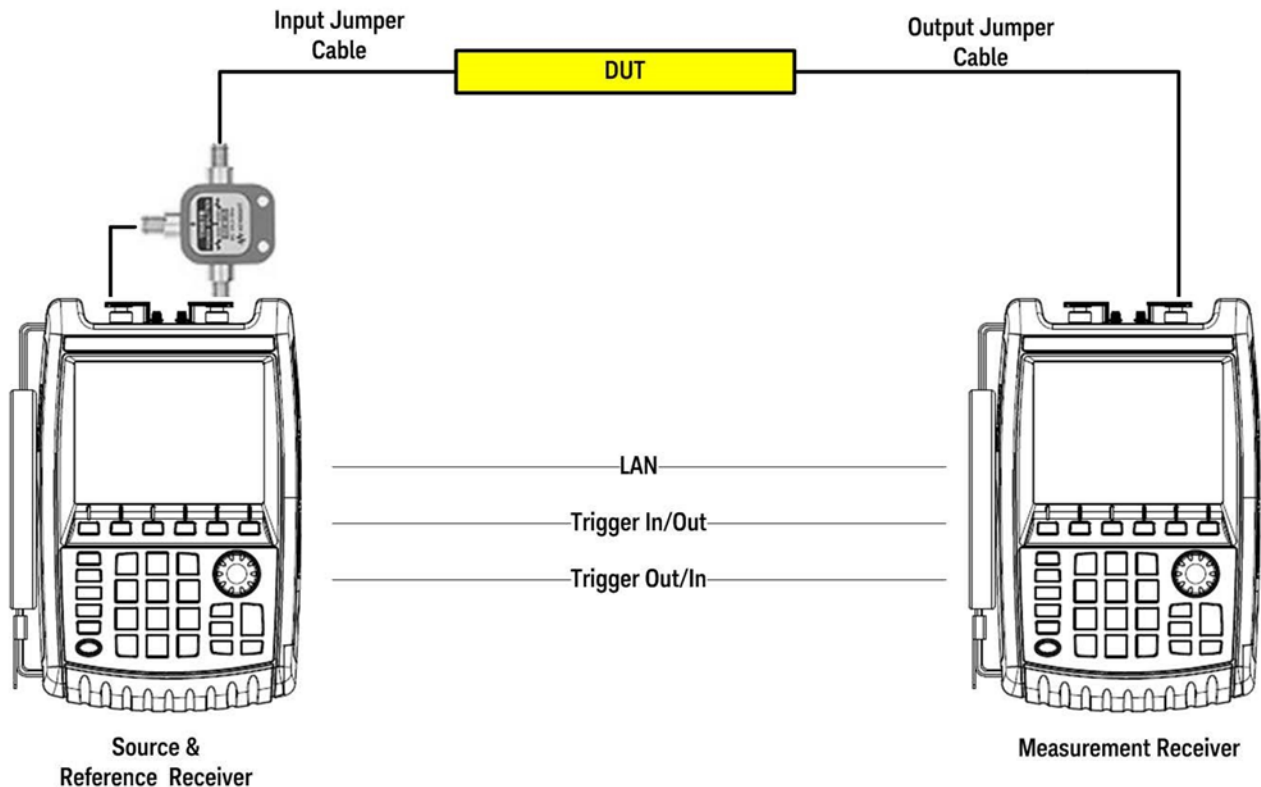

## ERTA (continued)

### Frequency specifications

The ERTA frequency range is limited by each individual analyzer's frequency range.

	Models	Source frequency range	Receiver frequency range <sup>1</sup>
<b>N991xB, N993xB</b>	N9913B, N9933B	30 kHz to 4 GHz	9 kHz to 4 GHz
	N9914B, N9934B	30 kHz to 6.5 GHz	9 kHz to 6.5 GHz
	N9915B, N9935B	30 kHz to 9 GHz	9 kHz to 9 GHz
	N9916B, N9936B	30 kHz to 14 GHz	9 kHz to 14 GHz
	N9917B, N9937B	30 kHz to 18 GHz	9 kHz to 18 GHz
	N9918B, N9938B	30 kHz to 26.5 GHz	9 kHz to 26.5 GHz
<b>N995xB, N996xB</b>	N9950B, N9960B	300 kHz to 32 GHz	9 kHz to 32 GHz
	N9951B, N9961B	300 kHz to 44 GHz	9 kHz to 44 GHz
	N9952B, N9962B	300 kHz to 50 GHz	9 kHz to 50 GHz
	N9953B, N9963B	300 kHz to 54 GHz	9 kHz to 54 GHz

#### Frequency reference

Refer to the frequency accuracy specifications.

#### Source output power

Refer to the test port output power typical data.

#### Frequency setup parameters

Receiver frequency	Center/span or start/stop (standard spectrum analyzer settings) Reverse receiver sweep direction (default direction is forward, but can be set to reverse)
Source frequency [Remote]	[Tracking] – FieldFox source tracks the receiver by default. The frequencies are identical. [CW] – FieldFox's source can be set to a CW frequency independent of FieldFox's receiver frequency. FieldFox's source is at a single CW frequency; FieldFox's receiver is swept. [Coupled CW] – FieldFox's source CW frequency is auto-coupled to FieldFox's receiver [Center Frequency] setting.

#### Frequency-offset capability

This feature allows the FieldFox's source frequency to be offset from FieldFox's receiver frequency. The offset frequency can be negative, zero, or positive. The frequency-offset capability is useful when characterizing the scalar transmission response of devices such as mixers and converters.

<sup>1</sup> The receiver (spectrum analyzer) is usable to 5 kHz, though only specified to 9 kHz.

## ERTA (continued)

### Frequency specifications (continued)

Frequency-offset setup parameters	
Receiver frequency	Center/span or start/stop (standard spectrum analyzer settings) Reverse receiver sweep direction (default direction is forward, but can be set to reverse)
Frequency tracking offset	On/Off Offset values: 0, > 0, < 0
Receiver sweep direction	Reversal: Off Default setting Both source and receiver sweep in the forward direction. Receiver stop frequency > Receiver start frequency $\text{Source frequency} = \text{Offset} + \text{Receiver frequency}$  Reversal: On Source and receiver sweep in opposite directions. $\text{Source frequency} = \text{Offset} - \text{Receiver frequency}$ Offset > receiver frequency

### Dynamic range and maximum attenuation

**Dynamic range** is the difference between the maximum output power available from FieldFox's source and the noise floor of the second FieldFox, while ensuring that neither FieldFox's ADC goes into over-range. Dynamic range also accounts for the loss of the power splitter. Dynamic range is applicable when testing devices such as filters, where there is low loss in the passband, and significant loss in the stopband, and both passband and stopband need to be on the display at the same time (same sweep).

**Maximum attenuation** is the difference between maximum output power available from FieldFox's source and the noise floor of FieldFox. It also accounts for the loss of power splitter. Maximum attenuation is applicable when testing devices such as cables, which have relatively uniform loss over the swept frequency range.

The values shown are based on the recommended minimum RBW of 3 kHz when the frequency references are locked via GPS, and 300 kHz when the frequency references are unlocked. Locking the frequency references to GPS allows for greater frequency accuracy of the FieldFox units and use of a narrower RBW, which in turn results in a lower DANL, and hence a wider measurement range. When the GPS signals cannot be present at all times, the GPS hold-over mode can be used.

## ERTA (continued)

### Dynamic range and maximum attenuation (continued)

Dynamic range (dB)				
Typical				
N991xB, N993xB	Preamp off	Preamp on	Preamp off	Preamp on
	Frequency references locked to GPS, RBW 3 kHz	Frequency references locked to GPS, RBW 3 kHz	Frequency references unlocked, RBW 300 kHz	Frequency references unlocked, RBW 300 kHz
> 2 MHz <sup>1</sup> to 6 GHz	88	83	68	63
> 6 to 13 GHz	86	83	66	63
> 13 to 22 GHz	70	86	50	66
> 22 to 25 GHz	63	83	43	63
> 25 to 26.5 GHz	58	77	38	57

Maximum attenuation (dB)				
Typical				
N991xB, N993xB	Preamp off	Preamp on	Preamp off	Preamp on
	Frequency references locked to GPS, RBW 3 kHz	Frequency references locked to GPS, RBW 3 kHz	Frequency references unlocked, RBW 300 kHz	Frequency references unlocked, RBW 300 kHz
> 2 MHz to 6 GHz	93	108	73	88
> 6 to 13 GHz	86	103	66	83
> 13 to 22 GHz	70	91	50	71
> 22 to 25 GHz	63	83	43	63
> 25 to 26.5 GHz	58	77	38	57

Dynamic range (dB)				
Typical				
N995xB, N996xB	Preamp off	Preamp on	Preamp off	Preamp on
	Frequency references locked to GPS, RBW 3 kHz	Frequency references locked to GPS, RBW 3 kHz	Frequency references unlocked, RBW 300 kHz	Frequency references unlocked, RBW 300 kHz
> 2 to 5 MHz	83	87	62	58
> 5 MHz to 11 GHz	93	97	69	68
> 11 to 19 GHz	95	96	71	70
> 19 to 22 GHz	93	94	69	68
> 22 to 40 GHz	88	90	63	65
> 40 to 43 GHz	82	89	57	64
> 43 to 46 GHz	81	93	56	68
> 46 to 50 GHz	77	88	52	63

Dynamic range is decreased from 3 to 9 dB at 2 MHz.

Maximum attenuation (dB)				
N995xB, N996xB	Typical			
	Preamp off	Preamp on	Preamp off	Preamp on
	Frequency references locked to GPS, RBW 3 kHz	Frequency references locked to GPS, RBW 3 kHz	Frequency references unlocked, RBW 300 kHz	Frequency references unlocked, RBW 300 kHz
> 2 MHz to 13 GHz	100	113	74	88
> 13 to 18 GHz	101	110	76	85
> 18 to 22 GHz	99	108	74	83
> 22 to 35 GHz	95	105	70	80
> 35 to 40 GHz	88	100	63	75
> 40 to 46 GHz	81	93	56	63
> 46 to 50 GHz	77	88	52	63

### Absolute power and gain measurement uncertainties

Verified with input level of -10 dBm, peak detector, 10 dB attenuation, preamplifier off, all settings auto-coupled, no warm-up required. Includes frequency response uncertainties. Assumes an ERTA system using a Keysight 11667A, 11667B, or 11667C power splitter.

N991xB and N993xB				
Input power (R) measurements uncertainty, 30 kHz RBW (dB)				
	Spec (23 ± 5 °C)	Spec (-10 to 55 °C)	Typical (23 ± 5 °C)	Typical (-10 to 55 °C)
100 kHz to 18 GHz	± 1.10	± 1.30	± 0.40	± 0.50
> 18 to 26.5 GHz	± 1.40	± 1.50	± 0.50	± 0.60
Output power (B) measurement uncertainty, frequency references locked to GPS, RBW ≥ 3 kHz (dB)				
100 kHz to 18 GHz	± 1.00	± 1.20	± 0.40	± 0.50
> 18 to 26.5 GHz	± 1.20	± 1.40	± 0.50	± 0.60
Output power (B) measurement uncertainty, frequency references unlocked, RBW ≥ 300 kHz (dB)				
100 kHz to 18 GHz	± 1.00	± 1.30	± 0.40	± 0.50
> 18 to 26.5 GHz	± 1.40	± 1.60	± 0.50	± 0.60
Gain/Loss (B/R) measurement uncertainty, frequency references locked to GPS, RBW ≥ 3 kHz (dB)				
100 kHz to 18 GHz	± 1.30	± 1.70	± 0.60	± 0.70
> 18 to 26.5 GHz	± 1.70	± 2.10	± 0.70	± 0.90
Gain/Loss (B/R) measurement uncertainty, frequency references unlocked, RBW ≥ 300 kHz (dB)				
100 kHz to 18 GHz	± 1.40	± 1.70	± 0.70	± 0.70
> 18 to 26.5 GHz	± 2.00	± 2.10	± 0.90	± 1.00

**N995xB and N996xB****Input power (R) measurements uncertainty, 30 kHz RBW (dB)**

	Spec (23 ± 5 °C)	Spec (-10 to 55 °C)	Typical (23 ± 5 °C)	Typical (-10 to 55 °C)
2 MHz to 18 GHz	± 1.10	± 1.30	± 0.50	± 0.60
> 18 to 32 GHz	± 1.20	± 1.50	± 0.50	± 0.70
> 32 to 40 GHz	± 1.30	± 1.80	± 0.60	± 0.80
> 40 to 43 GHz	± 1.60	± 2.30	± 0.70	± 1.10
> 43 to 50 GHz	± 1.70	± 3.20	± 0.80	± 1.40

**Output power (B) measurement uncertainty, frequency references locked to GPS, RBW ≥ 3 kHz (dB)**

2 MHz to 18 GHz	± 0.40	± 1.00	± 0.40	± 0.50
> 18 to 32 GHz	± 0.45	± 1.30	± 0.40	± 0.60
> 32 to 40 GHz	± 0.50	± 1.50	± 0.50	± 0.70
> 40 to 43 GHz	± 0.80	± 2.30	± 0.70	± 1.00
> 43 to 50 GHz	± 0.90	± 3.00	± 0.80	± 1.40

**Output power (B) measurement uncertainty, frequency references unlocked, RBW ≥ 300 kHz (dB)**

2 MHz to 18 GHz	± 1.00	± 1.10	± 0.40	± 0.50
> 18 to 32 GHz	± 1.20	± 1.50	± 0.50	± 0.60
> 32 to 40 GHz	± 1.60	± 1.90	± 0.60	± 0.80
> 40 to 43 GHz	± 2.10	± 2.50	± 0.70	± 1.30
> 43 to 50 GHz	± 2.60	± 3.60	± 1.00	± 1.60

**Gain/Loss (B/R) measurement uncertainty, frequency references locked to GPS, RBW ≥ 3 kHz (dB)**

2 MHz to 18 GHz	± 1.40	± 1.70	± 0.60	± 0.70
> 18 to 32 GHz	± 1.50	± 2.00	± 0.70	± 0.90
> 32 to 40 GHz	± 1.60	± 2.30	± 0.80	± 1.00
> 40 to 43 GHz	± 2.20	± 3.10	± 1.00	± 1.40
> 43 to 50 GHz	± 2.40	± 4.00	± 1.20	± 1.90

**Gain/Loss (B/R) measurement uncertainty, frequency references unlocked, RBW ≥ 300 kHz (dB)**

2 MHz to 18 GHz	± 1.40	± 1.70	± 0.70	± 0.70
> 18 to 32 GHz	± 1.80	± 2.10	± 0.80	± 1.00
> 32 to 40 GHz	± 2.10	± 2.80	± 1.00	± 1.30
> 40 to 43 GHz	± 2.70	± 3.50	± 1.40	± 1.70
> 43 to 50 GHz	± 3.00	± 4.80	± 1.60	± 2.40

**Cable correction**

Input and output jumper cable losses can be accounted for using ERTA's cable correction wizard.

The performance listed in built-on power meter, external USB power sensor support, pulse measurements, USB power sensor measurements versus frequency sections applies to the capabilities available in the following models:

FieldFox RF & microwave (combination) analyzers:	N9913B, N9914B, N9915B, N9916B, N9917B, N9918B
FieldFox RF & microwave signal analyzers:	N9933B, N9934B, N9935B, N9936B, N9937B, N9938B
FieldFox microwave (combination) analyzers	N9950B, N9951B, N9952B, N9953B
FieldFox microwave signal analyzers	N9960B, N9961B, N9962B, N9963B

See [FieldFox Configuration Guide](#) for option information. Many capabilities listed in this Data Sheet require options.

## Built-in Power Meter (Option 310)

Using the built-in power meter, FieldFox is able to make very accurate channel power measurements. The channel bandwidth can be set wide to simulate average power meter measurements. This measurement function provides the flexibility to make user definable channel power measurements.

	Description		
Setup parameters	Center frequency, including selection of radio standards and channel selection, span or channel width		
Functions	Relative/absolute measurements, offsets, units of dBm or Watts, or dB or %, minimum and maximum limits		
	Models	Frequency range	
<b>N991xB, N993xB</b>	N9913B, N9933B	9 kHz to 4 GHz	Usable to 5 kHz
	N9914B, N9934B	9 kHz to 6.5 GHz	Usable to 5 kHz
	N9915B, N9935B	9 kHz to 9 GHz	Usable to 5 kHz
	N9916B, N9936B	9 kHz to 14 GHz	Usable to 5 kHz
	N9917B, N9937B	9 kHz to 18 GHz	Usable to 5 kHz
	N9918B, N9938B	9 kHz to 26.5 GHz	Usable to 5 kHz
<b>N995xB, N996xB</b>	N9950B, N9960B	9 kHz to 32 GHz	Usable to 5 kHz
	N9951B, N9961B	9 kHz to 44 GHz	Usable to 5 kHz
	N9952B, N9962B	9 kHz to 50 GHz	Usable to 5 kHz
	N9953B, N9963B	9 kHz to 54 GHz	Usable to 5 kHz



### Total absolute amplitude accuracy (dB)

10 dB attenuation, input signal -15 to -5 dBm, peak detector, 300 Hz RBW, all settings auto-coupled, includes frequency response uncertainties. No warm-up required.

<b>N991xB, N993xB</b>	<b>Spec (-10 to 55 °C)</b>	<b>Typical (-10 to 55 °C)</b>
9 kHz to 100 kHz	± 2.00	± 0.25
> 100 kHz to 500 MHz	± 0.80	± 0.20
> 500 MHz to 16.3 GHz	± 1.00	± 0.20
> 16.3 to 18 GHz	± 1.00	± 0.30
≥ 18 GHz to 26.5 GHz	± 1.10	± 0.35
<b>N995xB, N996xB</b>	<b>Spec (-10 to 55 °C)</b>	<b>Typical (-10 to 55 °C)</b>
9 to 500 kHz	± 2.50	± 0.79
> 500 kHz to 15 MHz	± 1.10	± 0.38
> 15 MHz to 18 GHz	± 1.10	± 0.18
> 18 to 26.5 GHz	± 1.20	± 0.21
> 26.5 to 32 GHz	± 1.50	± 0.30
> 32 to 36 GHz	± 1.90	± 0.33
> 36 to 44 GHz	± 1.90	± 0.34
> 44 to 50 GHz	± 1.90	± 0.35
> 50 to 54 GHz	± 3.50	± 0.73

## External USB Power Sensor Support (Option 302)

The external USB power sensor option supports various Keysight USB power sensors. For an up-to-date listing of the supported power sensors, visit <http://www.keysight.com/find/fieldfoxsupport>

	<b>Description</b>
Setup parameters	Frequency
Functions	Relative/absolute measurements, offsets, units of dBm or Watts, or dB or %, minimum and maximum limits.
Internal source	FieldFox's internal source can be turned on in the USB power sensor mode. CW frequency and nominal power level control are available.

## Pulse Measurements (Option 330)

FieldFox's pulse measurement option can be used to characterize RF pulses such as those used in radar and electronic warfare systems. Measurements are made using FieldFox and Keysight's USB peak power sensors.

Performance specifications such as frequency, dynamic range and minimum pulse width depend on the peak power sensor. Supported peak power sensors: <http://www.keysight.com/find/fieldfoxsupport>

	Description
Setup parameters	Frequency, time (center), time/division, gating, triggering, video bandwidth, averaging
Functions	Average power, peak power, and peak to average ratio
	Analog gauge display and digital display, dBm and Watts
	Relative/absolute measurements, offset, dB or %, minimum and maximum limits
	Trace graph for pulse profiling with gating
	Rise time, fall time, pulse width, pulse period, pulse repetition frequency

## USB Power Sensor Measurements versus Frequency (Option 208)

This feature allows FieldFox's source frequency to be set independently from the power sensor (receiver) frequency. With frequency-offset using power sensor (FOPS), the frequency of both the source and receiver are swept, and the two track each other. The offset frequency can be negative, zero, or positive.

FOPS can be used to characterize the scalar transmission response of devices such as mixers and converters. This frequency-offset capability is necessary for conversion loss/gain measurements on frequency-translating devices, since, by definition, the input and output frequencies of the DUT are different. The FieldFox source stimulates the DUT and the power sensor is used as the measurement receiver.

Since power sensors are inherently broadband devices (not frequency-selective), the user should ensure that only the signal of interest is present at the power sensor input and that all other signals are filtered appropriately.

## USB Power Sensor Measurements versus Frequency (continued)

Setup parameters	
Source frequency	Center/span or start/stop
Receiver frequency	Range determined by power sensor range
Frequency offset	Positive offset or negative offset
Frequency step size	30 kHz minimum
Number of points	2 to 1601 (Combination of number of points and frequency step size limited by span.)
Dwell time/point	0 to 1.0 sec

Source frequency span must be equal to receiver frequency span.

Receiver sweep direction: forward (default setting) or reverse.

For some DUTs, the output frequency may sweep in a reverse direction, as compared to the source frequency. The basic relationships between the source, receiver and offset frequencies are shown in the table below. The FieldFox analyzer includes an offset calculator that ensures a fast measurement setup.

Src sweep direction	Rx sweep direction	Frequency calculations
Forward $f_{2_{src}} > f_{1_{src}}$	Forward $f_{2_{rx}} > f_{1_{rx}}$	Receiver frequency = Source frequency $\pm$ Offset
Forward $f_{2_{src}} > f_{1_{src}}$	Reverse $f_{2_{rx}} > f_{1_{rx}}$	Receiver frequency = Offset - Source Frequency Offset > Source frequency

	Description
Measurements	Source power, gain/loss and receiver (Rx) power Gain = Rx power / source power (memory). Source power (memory) is measured during setup.
Output power	Refer to the test port output power typical data on page 5.
Dynamic range	The dynamic range with FOPS is dependent on FieldFox's output power and the power sensor's dynamic range. Supported USB power sensors: <a href="http://www.keysight.com/find/fieldfoxsupport">www.keysight.com/find/fieldfoxsupport</a>

The graph below shows a filter measurement using two different power sensors, the U2002A (- 60 to +20 dBm) and the U2021XA (- 45 to +20 dBm). While a filter is not commonly measured using FOPS, it is a useful device for demonstrating dynamic range.

For both measurements, the FieldFox source power was set to - 1 dBm, the maximum available in the selected frequency range of 7.25 to 13.25 GHz. An external amplifier was not used in this case, but one can be added to increase the source power and hence dynamic range.

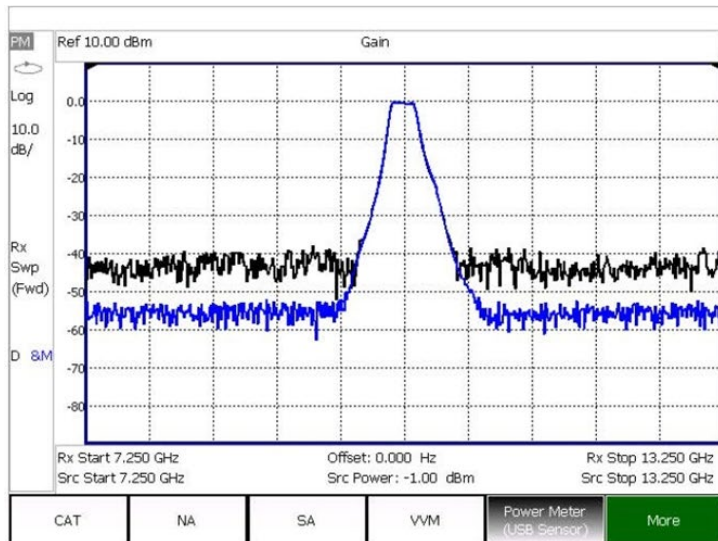

Example showing typical dynamic range of FOPS

## Built-In GNSS (GPS+) Receiver (Option 307)

	Description
GNSS (GPS+) receiver	The internal GNSS/GPS receiver can be used as a frequency reference. <sup>1</sup>
Supported systems	GPS, GLONASS, BeiDou and Galileo
Modes	Off, internal, external
Sync clock	On, off
Functionality	Geo-location: latitude, longitude, altitude (elevation), time, sync time/date Requires external GNSS/GPS antenna (can use N9910X-825, GPS active antenna)
Connector for antenna	SMA (f), 3.3 or 5 V
Maximum DC current	20 mA

## DC Bias Variable-Voltage Source (Option 309)

	Description
	Nominal
Connector	SMB (m)
Voltage	+1 to +32 V
Resolution	0.1 V
Maximum current <sup>2</sup>	0.65 A
DC current readout resolution	0.01 A
Maximum power <sup>2</sup>	7 watts
Display read out	Voltage, current
Overload trip protection	Automatically engages when voltage source is on. The trip circuit can be reset from front panel without pre-setting or power cycling the analyzer.

<sup>1</sup> External GPS USB receivers can be used to provide geo-location data. However, they cannot be used for frequency reference locking.

<sup>2</sup> Battery life will be reduced when DC source is used. A trip function turns off the power supply when the rated current or power is exceeded.

## Remote Control Capability (Option 030)

Option 030 adds remote control capability to FieldFox analyzers, so that FieldFox can be controlled via an iOS device, or an Android device. The FieldFox app, running on the iOS/Android device, combined with Option 030 on the FieldFox analyzer provides full control of the instrument from a remote location. The app emulates the front panel of FieldFox, so users can press the FieldFox hard keys or softkeys using their iPhone/iPad, or Android mobile device and make measurements remotely. For example, a tower climber can be on the tower with a FieldFox analyzer, while the technician controls and makes the measurements down below, using an iPad. The iPad and FieldFox communicate via a network connection.

iOS device requirements	Android device requirements
iPad, iPhone, or iPod Touch	Android phone, tablet PC
iOs of 6.1 or higher	Android OS of 9.0 or higher
A WiFi or cellular network connection	A WiFi or cellular network connection

The FieldFox app communicates with FieldFox via a network connection, so both the iOS/Android device and FieldFox need to be on a network where both devices can reach the other. For example, a company intranet or a site installation using a wireless router. FieldFox can directly be connected to a LAN cable, or if wired LAN is not available, a user supplied wireless router can be configured to work with FieldFox. FieldFox does not include a wireless router.

### FieldFox app without Option 030

The FieldFox app can be installed on an iOS or an Android device independent of the presence of Option 030 on the analyzer. Without Option 030, users can view the live display screen of their FieldFox remotely but cannot control the instrument. With 030 purchased and installed on their FieldFox, users can both view and control their FieldFox. Control refers to the ability to press hard keys, softkeys, make or change measurements, etc. Option 030 does not include the iOS or the Android device itself. Users must supply their own iOS or Android device. Option 030 is a license on the FieldFox analyzer. Option 030 and the FieldFox app are not applicable to BlackBerry, or Windows phone/tablet devices. FieldFox can be remotely controlled via PC software using a wireless or wired LAN connection. FieldFox Data Link software provides a remote display tool with a virtual keypad that allows remote access to the FieldFox display (Option 030 not required).

## EMI measurements (Option 361)

	Description
Frequency Range	Same as spectrum analyzer frequency range
Number of traces	4, each trace can be configured with individual trace mode and detector type
Trace mode	Max hold, Min, Clear/Write, View and blank. (Average is implemented as EMI average detector)
Detector	Positive Peak, Quasi-Peak, EMI average
CISPR bandwidth	200 Hz, 9 kHz, 120 kHz, 1MHz
Measurements	Frequency scan, CISPR 16-1-1 Amplitude probability distribution (APD)

## General Information

<b>Calibration cycle</b>	
	1 year
<b>Weight</b>	
N991xB, N993xB, N995xB, N996xB	3.34 kg or 7.35 lb. including battery (approx.)
<b>Dimensions: H x W x D</b>	
	292 x 188 x 82 mm (11.5 in x 7.4 in x 3.2 in) (approx.)
<b>Environmental</b>	
MIL-PRF-28800F Class 2	Operating temperature Storage temperature Operating humidity Random vibration Functional shock Bench drop

---

## General Information (continued)

Environmental (continued)	
Maximum humidity	Maximum relative humidity (non-condensing): 95% relative humidity up to 40°C, decreases linearly to 45% relative humidity at 55°C <sup>1</sup>
Altitude – operating	9,144 m or 30,000 ft (using battery)
Altitude – Non-operating	15,240 m or 50,000 ft
Altitude – AC to DC adapter	3,000 m or 9,840 ft
Ingress protection	
	This product has been type tested to meet the requirements for ingress protection IP53 in accordance with IEC/EN 60529 (IP rating for instrument by itself, with no cover).
Temperature range	
Operating, AC power, spec <sup>2</sup>	-10 to 55°C (14 to 131°F) (-10 to 45°C/14 to 113°F in RTSA mode)
Operating, battery, spec	-10 to 50°C (14 to 122°F)
Operating, battery, typical	-10 to 55°C (14 to 131°F)
Storage, spec <sup>3,4</sup>	-51 to 71°C (-60 to 160°F)
<b>EMC:</b> Complies with the essential requirements of the European Radio Equipment Directive as well as current editions of the following standards (dates and editions are cited in the Declaration of Conformity):	
	IEC/EN 61326-1
	EN 301 489-1, EN 301 489-19
	CISPR Pub 11 Group 1, Class B
	AS/NZS CISPR 11
	ICES/NMB-001
	This ISM device complies with Canadian ICES-001. Cet appareil ISM est conforme a la norme NMB-001 du Canada.
<b>Radio Equipment (GNSS):</b> Complies with the essential requirements of the European Radio Equipment Directive:	
	EN 303 413
<b>SAFETY:</b> Complies with the essential requirements of the European Low Voltage Directive as well as current editions of the following standards (dates and editions are cited in the Declaration of Conformity):	
	IEC/EN 61010-1
	Canada: CSA C22.2 No. 61010-1
	USA: UL std no. 61010-1
To find a current Declaration of Conformity for a specific Keysight product, go to: <a href="http://www.keysight.com/go/conformity">http://www.keysight.com/go/conformity</a>	
Explosive environment	
	This product has been type tested to meet the requirements for operation in explosive environments in accordance with MIL-STD-810G, Method 511.5, Procedure I.

<sup>1</sup> From 40°C to 55°C, the maximum % relative humidity follows the line of constant dew point.

<sup>2</sup> Power supply: 0 to 40°C at 90 W output rating, derate linearly at 3 watts per degree C, to 45 W at 55°C, 30 W at -20°C.

<sup>3</sup> The battery packs should be stored in an environment with low humidity. Extended exposure to temperature above 45°C could degrade battery performance and life.

<sup>4</sup> Power supply: -40°C to 85°C (-40°F to 185°F).

## General Information (continued)

<b>Power supply</b>	
External DC input	15 to 19 VDC, 4 amps maximum when battery charging
External AC power adapter	Efficiency level VI
Input	100 to 240 VAC, 50 to 60 Hz, 1.5 to 0.75 A
Output	15 VDC, 6 A
Power consumption	16 to 30 watts (typical) Battery consumption depends on battery saver selection, measurement mode and temperature.
<b>Battery</b>	
Lithium ion	10.8 V, 6.4 A-h, 70 Wh
Operating time	4 hours (typical), mode dependent
Charge time	A fully discharged battery takes about 1.5 hours to recharge to 80%. Four hours to 100%.
Discharge temperature limits	-10 to 60°C, ≤ 85% RH
Charge temperature limits	0 to 45°C, ≤ 85% RH
Storage temperature limits	-20 to 50°C, ≤ 85 % RH  The battery packs should be stored in an environment with low humidity. Extended exposure to temperatures above 45°C could degrade battery performance and life.
<b>Test port connectors</b>	
Input impedance	50 Ω
Connector type	
≤ 18 GHz models	Type-N (f)
26.5 GHz models	3.5 mm (m) for FieldFox microwave analyzer, N9918B. On FieldFox SA N9938B, you may choose 3.5 mm (m) by ordering option N9938B-100 or Type-N (f) by default. Type-N (f) port connector is not available for the 26.5 GHz microwave analyzer, N9918B. 3.5 mm (m) connector, torque 0.90 Nm or 8 in-lb, use torque wrench N9910X-886
32, 44, 50 GHz models	2.4 mm (m), torque 0.90 Nm or 8 in-lb, use torque wrench N9910X-886
54 GHz models	1.85 mm (m), torque 0.90 Nm or 8 in-lb, use torque wrench N9910X-886
<b>Display</b>	
	6.5" transfective color LCD-LED backlit
<b>Headphone jack connector</b>	
	3.5 mm (1/8 inch) miniature audio jack
<b>USB-A, 2-ports</b>	
	Hi-speed USB 2.0
<b>Mini USB, 1 port</b>	
	Hi-speed USB 2.0; used for SCPI programming; USBTMC (USB IEEE488)
<b>Keyboard</b>	
	USB keyboards are supported (user must supply their own keyboard)
<b>LAN</b>	
Connector	RJ-45  Used for programming, data saving, remote control, and connection to DataLink software
N991xB, N993xB, N995xB, N996xB	1000/100/10 base-T (auto switching)  SCPI over LAN using sockets and VX11 (LAN IEEE488); HTTP



## General Information (continued)

<b>Programming</b>	SCPI, using the built-in LAN interface, PathWave BenchVue
<b>Languages</b>	English, Spanish, German, Italian, French, Russian, Japanese, Chinese, Turkish, Korean, and Portuguese
<b>Preset</b>	User preset for both mode preset and complete system preset
<b>Limit lines</b>	<p>The limit line capabilities listed in this section apply to the cable and antenna analyzer, network analyzer and spectrum analyzer modes in all FieldFox analyzers.</p> <ul style="list-style-type: none"><li>• Limit lines can be a combination of horizontal lines, sloping lines, or discrete data points</li><li>• Limit types: Fixed or relative</li><li>• Each trace can have its own limit line</li><li>• Limit lines can be built from a current trace</li><li>• Limit segments &gt; 100, limited by memory size</li><li>• Max limit line number of points: 10,001</li><li>• Beep: Beep off, Beep on fail, Beep on pass</li><li>• Pass/fail warning: on/off</li><li>• Offset and margin: An increase or decrease in the limit line</li><li>• Save/recall limit lines</li></ul>
<b>Data storage</b>	
Internal	Internal Minimum: 4 GB Minimum states and traces: 1000
External	Supports USB 2.0 compatible memory devices and SD/SDHC memory cards with FAT and exFAT format
Data types	Trace, trace+state, picture (png), data (csv), S1P, S2P
<b>Secure operation</b>	
Frequency blanking	For protection of sensitive data all frequency information can be turned off.
Erase user data	All user data can be erased on a FieldFox analyzer. For more information visit: <a href="http://www.keysight.com/find/securefieldfox">http://www.keysight.com/find/securefieldfox</a>
<b>Reference OUT/trigger OUT</b>	
Connector	SMB (m), 50 $\Omega$
Output amplitude	$\geq 0$ dBm
Frequency	10 MHz (1 + frequency reference accuracy)
Trigger out	Reserved for future use; currently only used for ERTA 2-box handshaking
<b>Reference IN/trigger IN</b>	
Connector	SMA (f), 50 $\Omega$
Reference input	10 MHz, - 5 to +10 dBm
Trigger input	3.3 or 5 V TTL logic levels

# FieldFox Physical Dimensions

FieldFox models with Type-N test port connectors

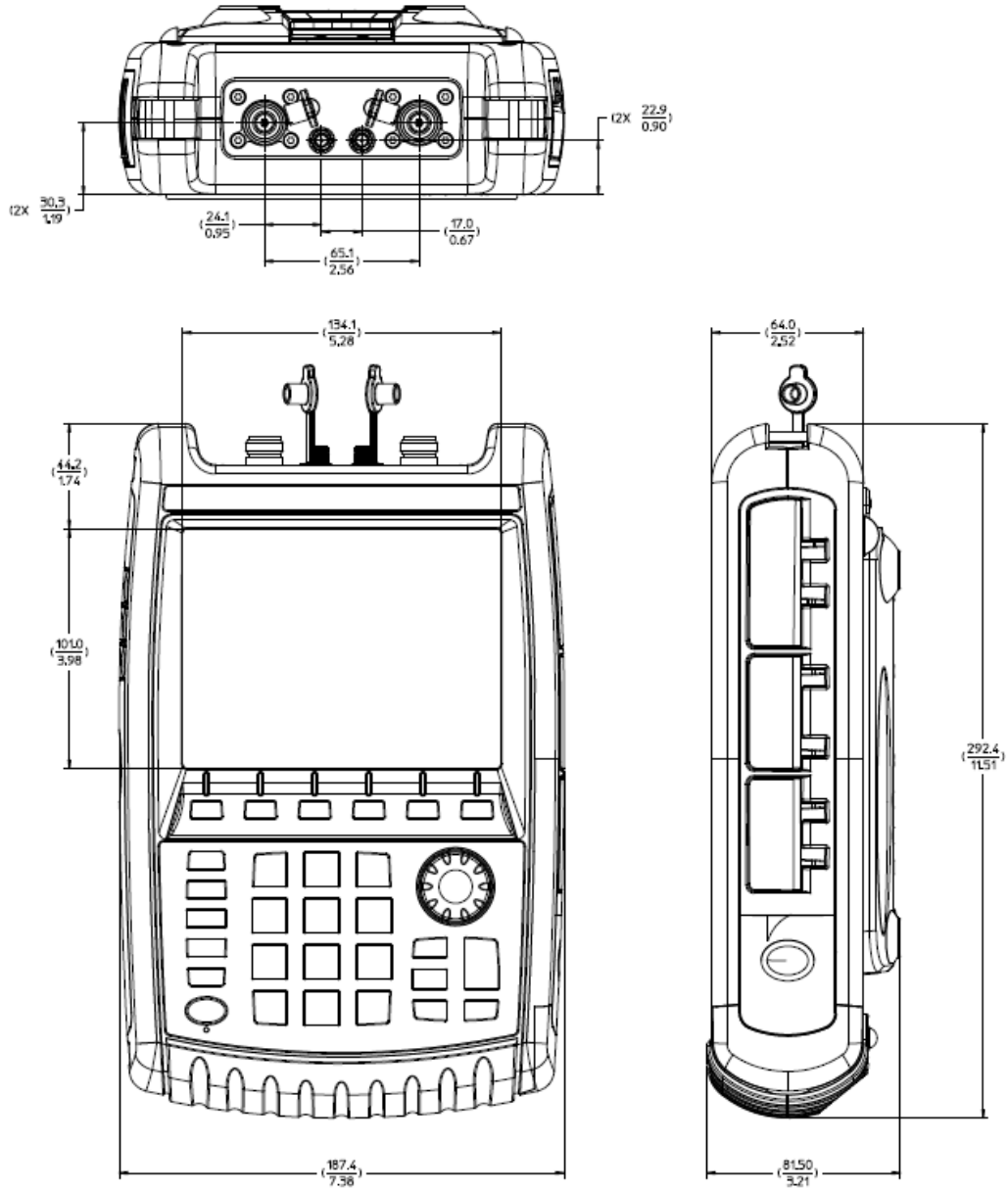

## FieldFox Physical Dimensions (continued)

FieldFox models with 3.5 mm test port connectors

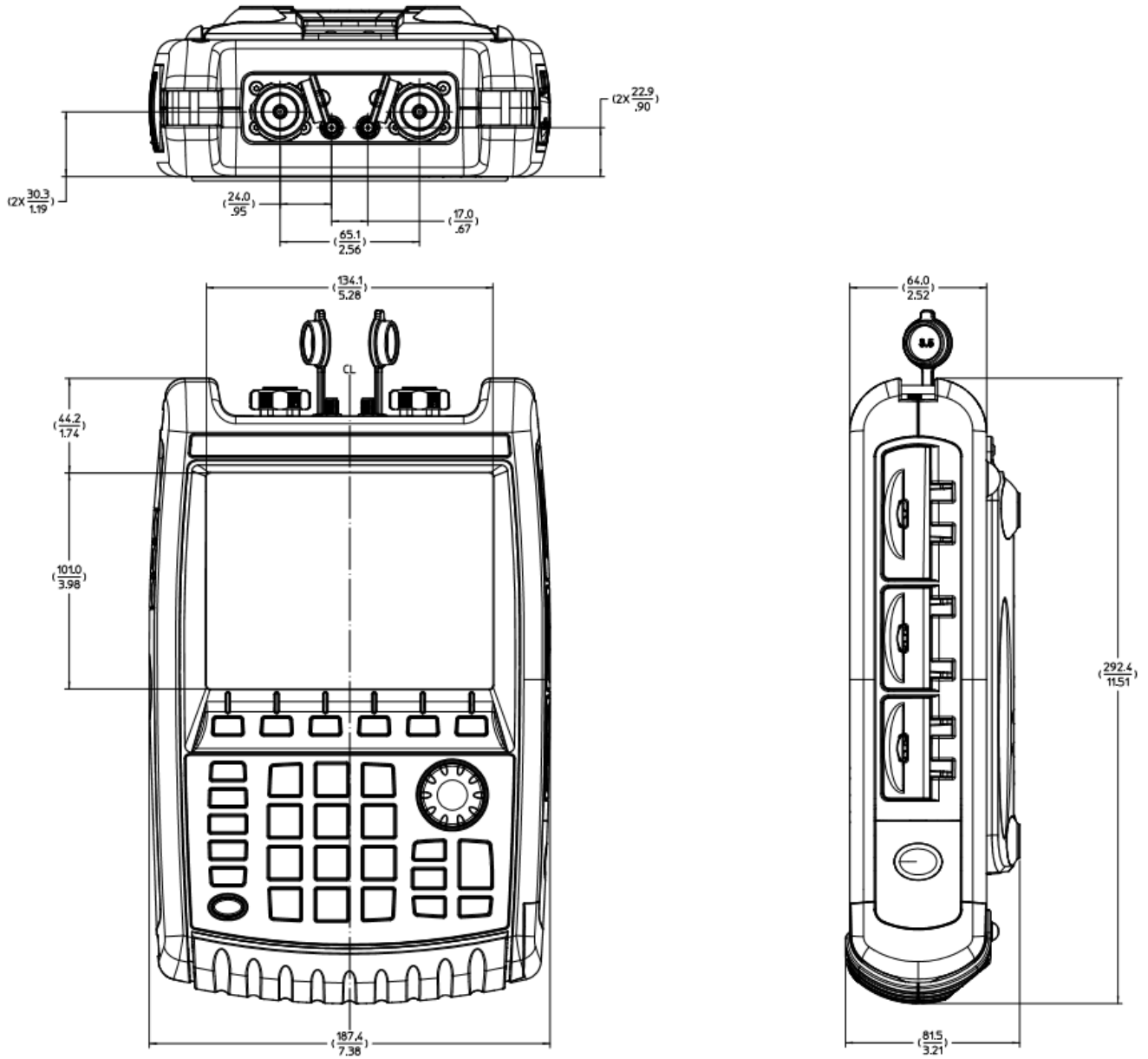

## FieldFox Physical Dimensions (continued)

FieldFox models with 2.4 mm test port connectors<sup>1</sup>

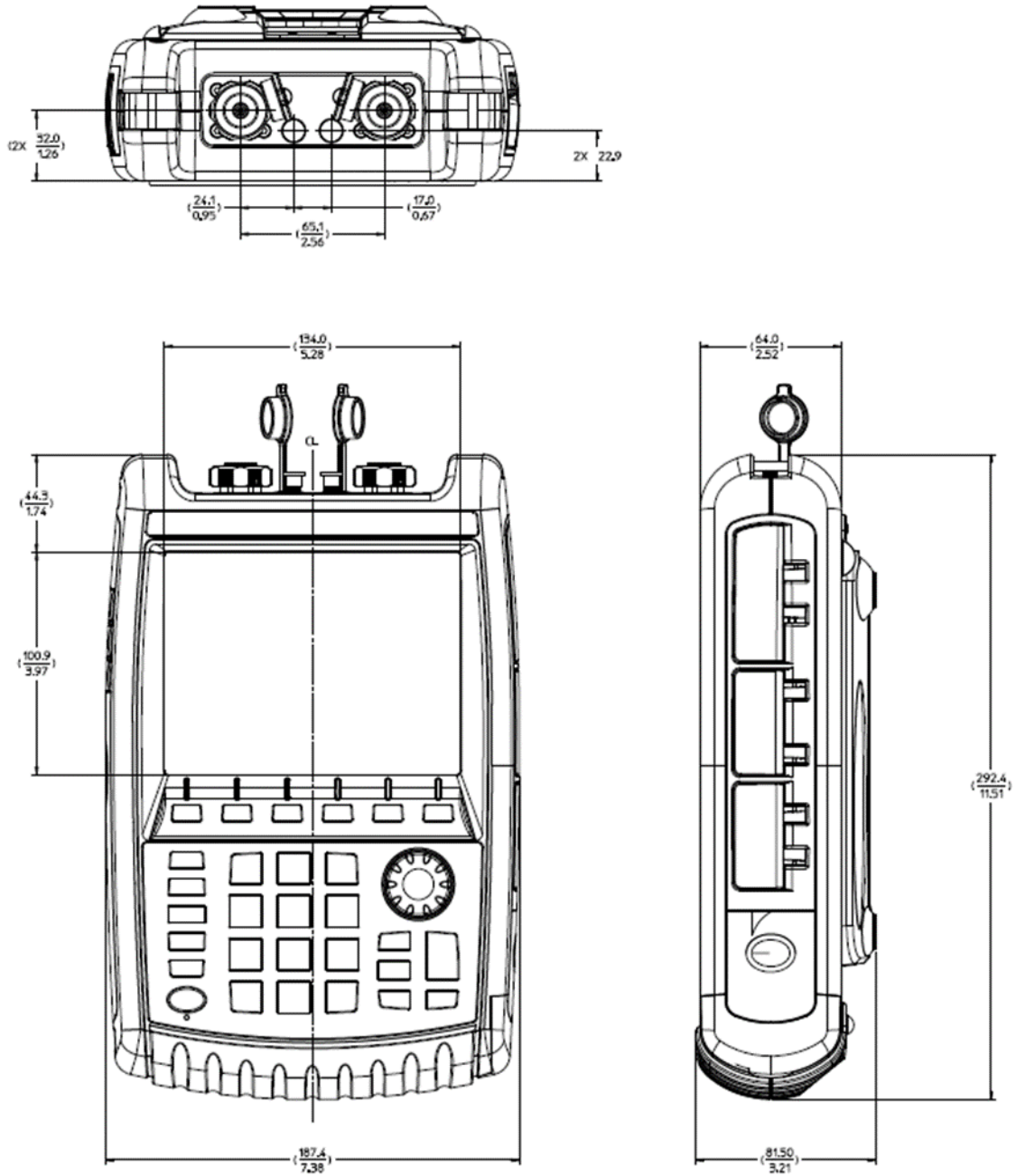

<sup>1</sup> Physical dimension measures shown in this drawing are also applicable to the FieldFox models with test port connectors of 1.85 mm (N9953B/N9963B).

## Carry Precision with You

Every piece of gear in your field kit had to prove its worth. Measuring up and earning a spot is the driving idea behind Keysight's FieldFox analyzers. They're equipped to handle routine maintenance, in-depth troubleshooting, and anything in between. Better yet, FieldFox delivers precise microwave measurements — wherever you need to go. Add FieldFox to your kit and carry precision with you.

Related literature	Publication number
FieldFox Handheld Analyzers, Configuration Guide	5992-3701EN
FieldFox Handheld Analyzers, Technical Overview	5992-3703EN

Download application notes, watch videos, and learn more: [www.keysight.com/find/fieldfox](http://www.keysight.com/find/fieldfox)

Learn more at: [www.keysight.com](http://www.keysight.com)

For more information on Keysight Technologies' products, applications, or services, please contact your local Keysight office. The complete list is available at: [www.keysight.com/find/contactus](http://www.keysight.com/find/contactus)

